

# **Bolero 11 and Bolero 21 OPERATING MANUAL**

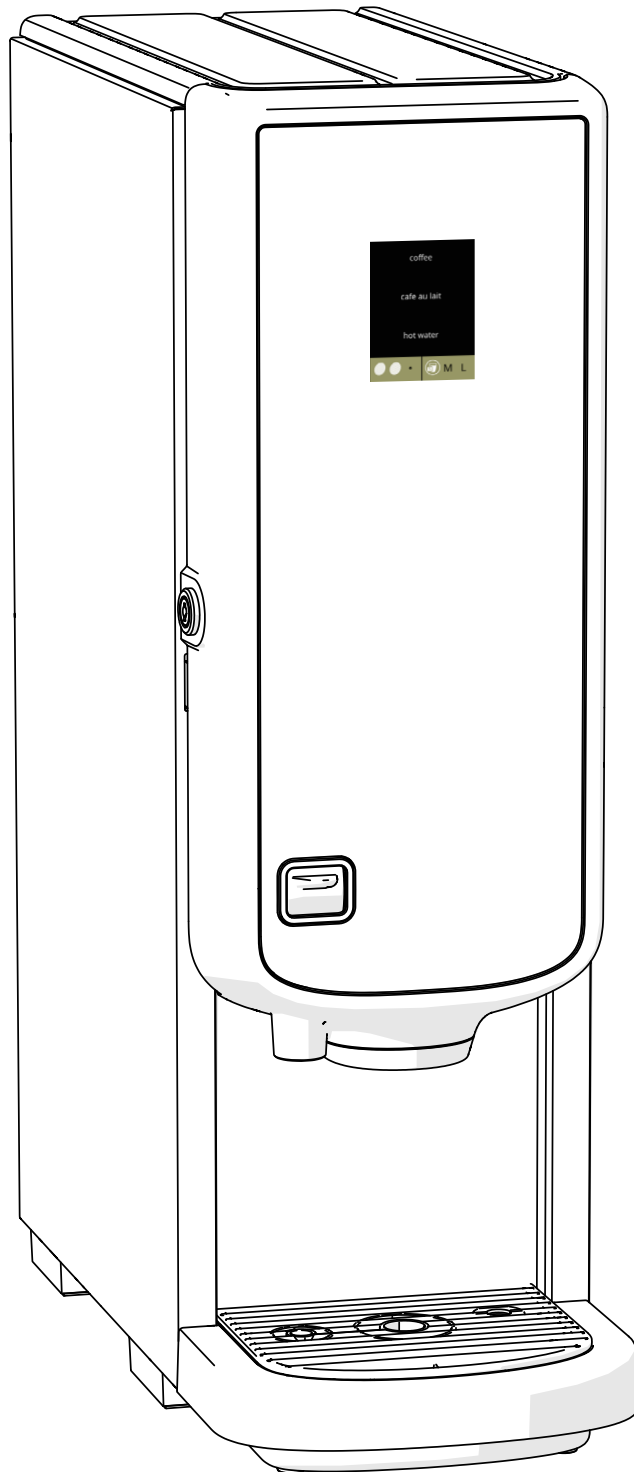

700.470.008 (Digital manual - English)

**HMI: V1.0.2**

**Model-no:** • BLR1-010  
• BLR2-010

All rights reserved.

No part of this document may be copied and/or published by means of printing, photocopying, microfilming or by any other means whatsoever without the prior written consent of the manufacturer. This also applies to the included drawings and/or diagrams.

The information in this document is based on data that was available at the time the design, the material characteristics and the operating methods were published, meaning that this document is subject to change.

For this reason, the instructions are merely a guideline for the installation, maintenance and repair of the machine displayed on the front cover.

This document applies to the standard version of this machine.

The manufacturer therefore declines all liability for any damage arising from specifications that deviate from the standard version of the machine delivered to you.

This document has been compiled with the utmost care. However, the manufacturer cannot be held liable for any errors it contains or the consequences thereof.

## Table of contents

<b>1. Parts and functions</b>	<b>1</b>
1.1 Parts	1
1.2 Optional water filter	1
1.3 Controls	2
<b>2. Start up</b>	<b>3</b>
<b>3. Your beverage</b>	<b>6</b>
3.1 Personalise your beverage	6
3.2 Cancelling instant related beverages	7
3.3 Hot water tap	7
3.4 Screensaver	8
3.5 Energy saving mode (ECO)	8
<b>4. Cleaning</b>	<b>9</b>
4.1 Daily cleaning	9
4.2 Weekly cleaning	11
<b>5. Programming menu</b>	<b>13</b>
5.1 Maintenance menu	14
5.1.1 Rinse the mixing system	15
5.1.2 Descale	17
5.1.3 Water filter management	24
5.1.4 Hot-key rinsing function	27
5.1.5 Cleaning management	28
5.1.6 Descale management	30
5.1.7 Canister calibration	33
5.1.8 Pump calibration	36
5.1.9 Input test	38
5.1.10 Output test	41
5.1.11 Cleaning instructions	44
5.1.12 Counters	47
5.2 Beverages menu	52
5.2.1 Add beverage to screen	53
5.2.2 Change beverage name	55
5.2.3 Change beverage price	56
5.2.4 Recipes	58
5.2.5 Select ingredient canisters	62
5.2.6 Change ingredient name	64

5.3	Machine menu	65
5.3.1	Year	66
5.3.2	Date	67
5.3.3	Time	68
5.3.4	Language	69
5.3.5	Screensaver management	70
5.3.6	Background	72
5.3.7	Display brightness	73
5.3.8	Sound level feedback	74
5.3.9	Boiler temperature	75
5.3.10	Energy-saving mode (ECO)	76
5.3.11	Security settings	78
5.3.12	Network settings	83
5.3.13	Connected devices	84
5.3.14	Reset to factory settings	85
5.4	Software menu	87
5.4.1	Machine and software information	88
5.4.2	Error log	89
5.4.3	Warning log	90
5.4.4	Import machine settings	91
5.4.5	Export machine settings	93
5.4.6	Update software	95
5.4.7	Export machine log	97
5.4.8	Update history	99
5.5	Online info	100
<b>6.</b>	<b>Messages and errors</b>	<b>101</b>
6.1	Warning messages	101
6.2	Errors	103
<b>7.</b>	<b>Appendix</b>	<b>106</b>
7.1	Filter information and water hardness	106
7.2	Door switch functionality	106
7.3	Basic machine configurations	106
7.4	PIN code security settings	107
7.6	Special functions	108
7.6.1	Cancel beverage on/off	108
7.6.2	Quick rinse	108
7.6.3	Demo mode on/off	108

# 1. Parts and functions

## 1.1 Parts

1. descaling cap
2. canisters
3. canister outlet
4. mixing system
5. hot water tap
6. beverage outlet
7. safety key
8. USB connection
9. programming button
10. door-key
11. drip tray plate
12. drip tray with float
13. ventilation system
14. water inlet
15. electrical connection
16. on/off switch

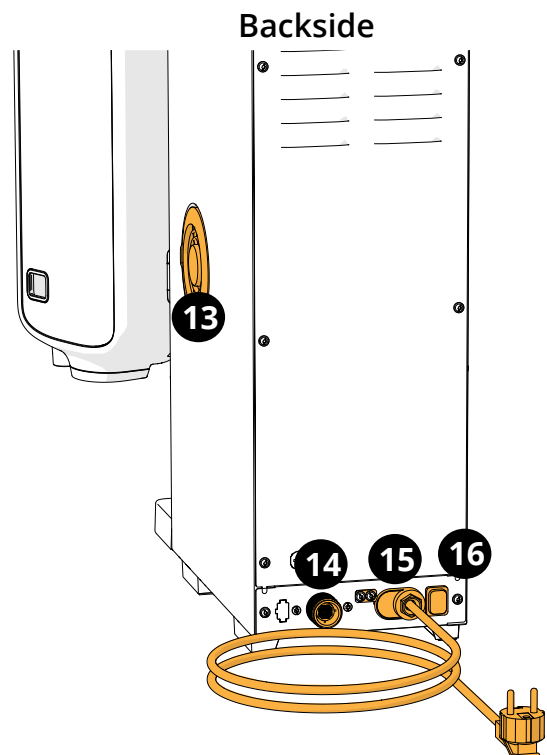
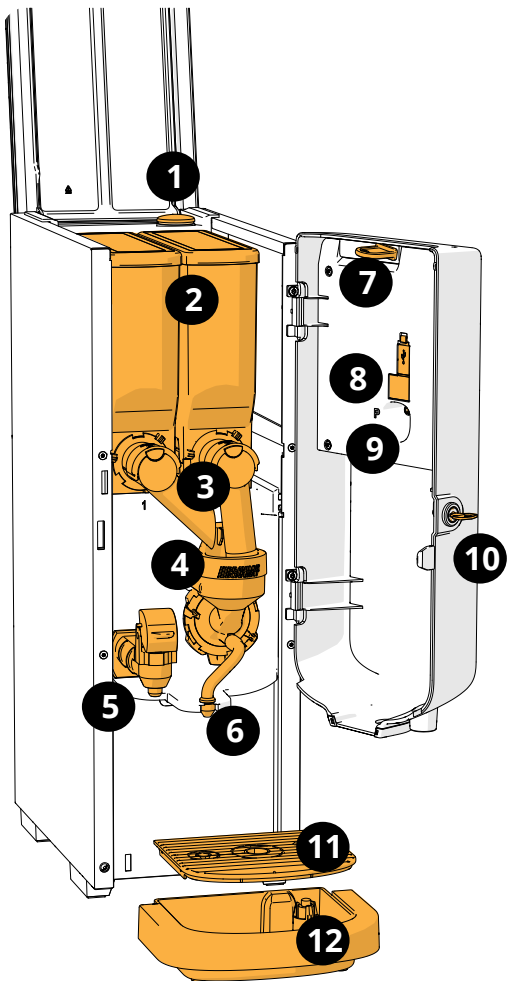

## 1.2 Optional water filter

To enjoy your beverages even more and improve the performance of your Bolero, we recommend installing a water softener filter. You can request one from Bravilor Bonamat BV.

- *When you install a water softener filter you must notify the Bolero of its presence as described in §5.1.3 on p.24.*

### 1.3 Controls

The basic buttons are described underneath.

Overall the Bolero reacts after the release when a button is pressed.

► *If no button is pressed within 5 minutes, the Bolero returns to the beverage selection screen.*

controls	function
< >	navigate between screens
start	start an action
✓	confirm ( <i>not saved yet</i> )
save	save adjustments
✕ cancel	cancel
< > ^ v	browse the available options on a screen
+ -	increase and decrease

► *All screen shots in this manual are in English.*

## 2. Start up

At start up, the Bolero can display different screens, depending on the status or the machine:

- first install **not yet** completed, the first screen is 2b
- first install **already** completed, the first screen is 2a

2a

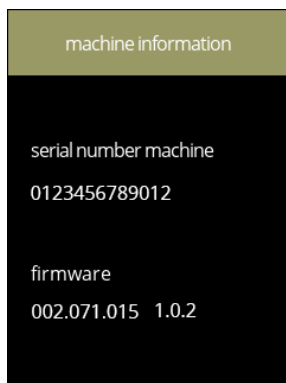

Machine information.



- after a few seconds the next screen will appear depending the status of the machine:

► *First install already completed, the next screen is 2h or 2i.*

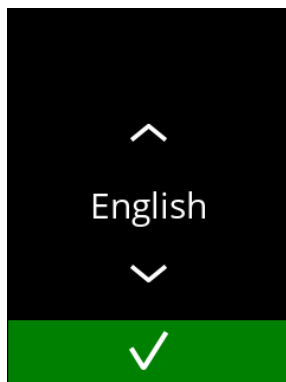
2b



First install, select your language:



- press  or  to scroll through the available languages
- press  to confirm

► *The installation menu is only shown when the machine is switched on for the first time or is switched on after the factory settings have been reset, see §5.3.14 on p.85.*

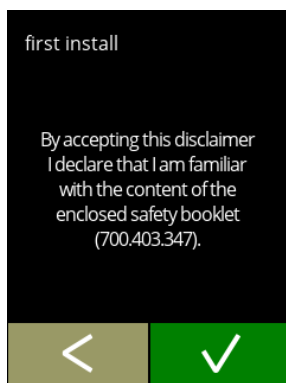
2c



Read the safety book!

- press  to go the previous screen
- press  to confirm

2d

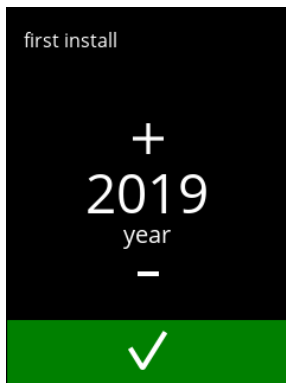

Set the year:

- press **+** or **-** to set the current year
- press **✓** to confirm

2e

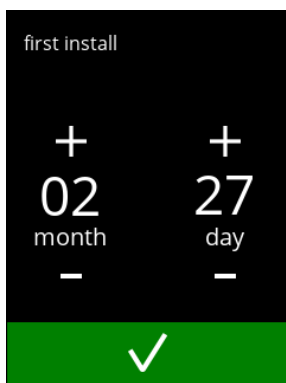

Set the day and month:

- press **+** or **-** to set the current day and month
- press **✓** to confirm

2f

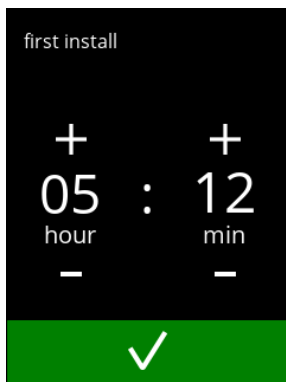

Set the time:

- press **+** or **-** to set the current the hour and minutes
- press **✓** to confirm

2g

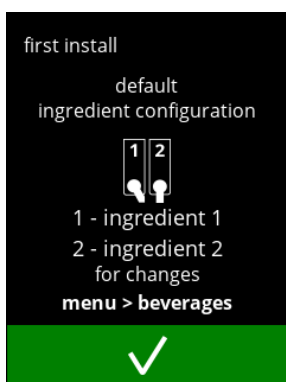

Information screen:

- fill the canisters with ingredients according to the instructions on the screen
- press **✓** to confirm
  - ▶ *The screen depends on the configuration of the machine, see §7.3 on p.106.*
  - ▶ *The values can be changed in the beverage menu, see §5.2.5 on p.62.*



2h

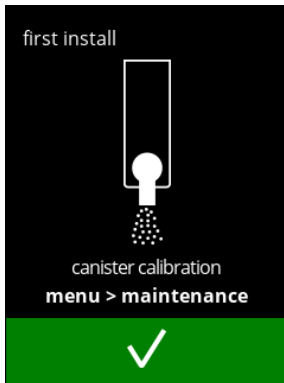

Information screen:

- press  to confirm

► *Calibration is essential for a correct dosage of the ingredients and can be done in the maintenance menu, see §5.1.7 on p.33.*

2i

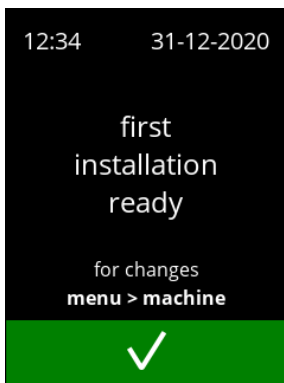

Information screen:

- press  to confirm

► *The date, time and language can be changed in §5.3 Machine menu on p.65.*

2j

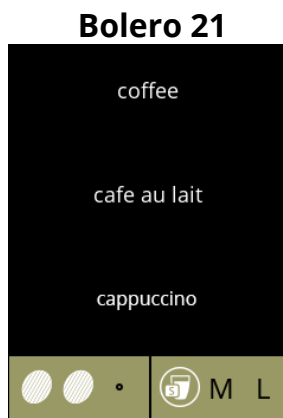

The machine is ready for use.

### 3. Your beverage

If you press on name the beverage prepares immediately.

If you want to personalise the drink, select one of the icons in fig. 3.1a, then press the drink of your choice.

#### 3.1 Personalise your beverage

► *These settings are used in preparing this one beverage and are not saved.*



##### Options

*Strength:*

- press the beans (carousel) to select the beverage strength



*Beverage size:*

the letters (S=small / M=medium / L=large) represents the three steps in volume

- press the "letters" (carousel) to select the beverage cup size

3.1a

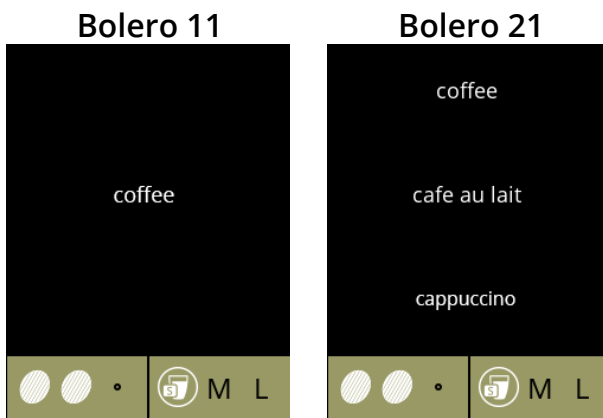

##### Selecting a beverage:

- touch the beverage of your choice

3.1b

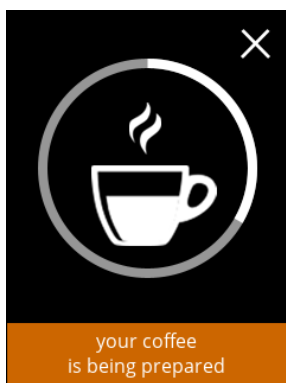

##### Preparing a beverage:

- please wait

3.1c

## 3.2 Cancelling instant related beverages

When a beverage is selected, immediately a cancel button appears.

The cancel button  may have a limited dimension but the dosing action can always be stopped wherever the screen is touched.

The cancel function is enabled by default and can only be turned off in

§5.3.13 Connected devices on p.84.

When a beverage is cancelled, the mixer continues to run for a few seconds to clean the mixing system.

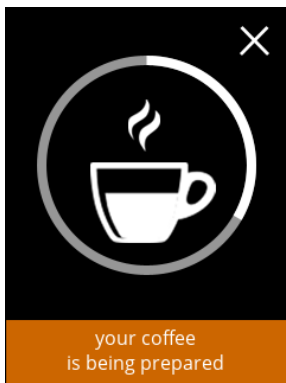

3.2a

### Cancel a beverage:

- touch anywhere on the screen to cancel the beverage

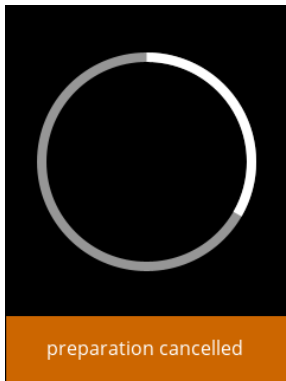

3.2b

### Information screen:

- this screen is displayed to indicate the beverage has been cancelled.

## 3.3 Hot water tap

The Bolero comes in two versions, with and without a manual hot water tap. The separate tap provides hot water for tea or soup.

The hot water tap is intended for filling a cup with plain hot water. Wait a few seconds between drawing off hot water and selecting a new beverage so that the machine can refill itself.

The hot water tap is not blocked if the water temperature is too low.

- ▶ *It is not allowed to tap hot water while preparing a drink, in order to prevent clogging of the mixing system.*

### 3.4 Screensaver

If the screen has not been touched for a certain time, the screensaver starts.  
The screensaver timer can be set in §5.3.5 on p.70.

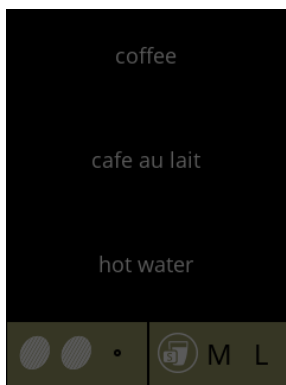

3.4a

Screensaver:

- touch anywhere on the screen to return to the beverage selection screen

### 3.5 Energy saving mode (ECO)

The device is equipped with an energy saving mode (ECO) this is used to save energy consumption when the machine is not used (e.g. overnight or during a weekend).

When energy-saving mode becomes active, the following actions are performed:

- water level control            disabled
- boiler heating                disabled
- backlight display            set to low percentage.
- fan                                disabled



3.5a

The energy control consist out of a (customised) screensaver with a symbol as semi transparent overlay.

The energy-saving mode has priority over the screensaver.

- touch anywhere on the screen to return to the beverage selection screen
- ▶ *Depending on the switch-off time, it can take a few minutes before the machine is ready for use again.*

## 4. Cleaning

It is important that the Bolero is kept clean, what can be cleaned:

daily	weekly
drip tray	canister(s)
mixing system	ventilation system
the outside	the inside

- ▶ *Never clean parts of the Bolero in the dishwasher, only if this is explicitly stated.*
- ▶ *Do not use any aggressive cleaning agents.*
- ▶ *See also the cleaning programmes in §5.1 on p.14.*

### 4.1 Daily cleaning

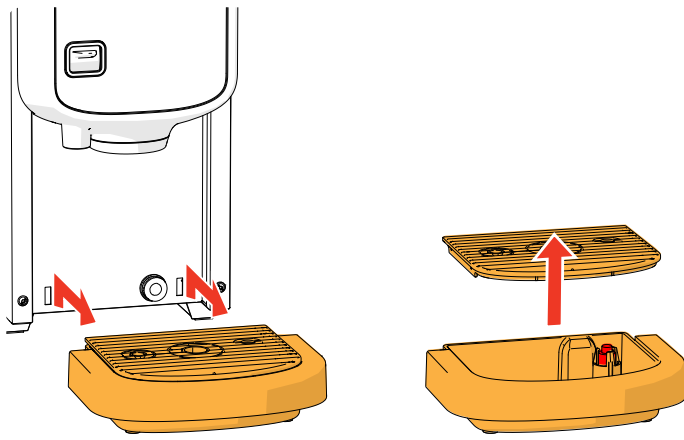

#### Drip tray:

1. pull the complete drip tray forward
  2. empty the drip tray
  3. clean the drip tray (including grid), using *hot soapy water*
  4. dry everything and place them back in place
- ▶ *Check whether the "red float" is still in place*

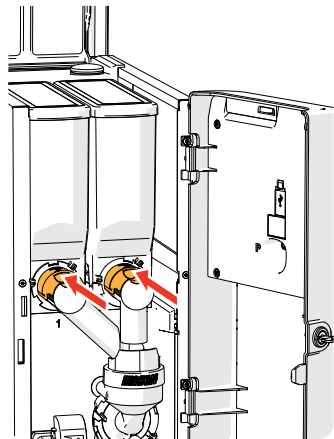

#### Mixing system:

1. open the door and lid
2. close the "yellow" slider of the canister outlets

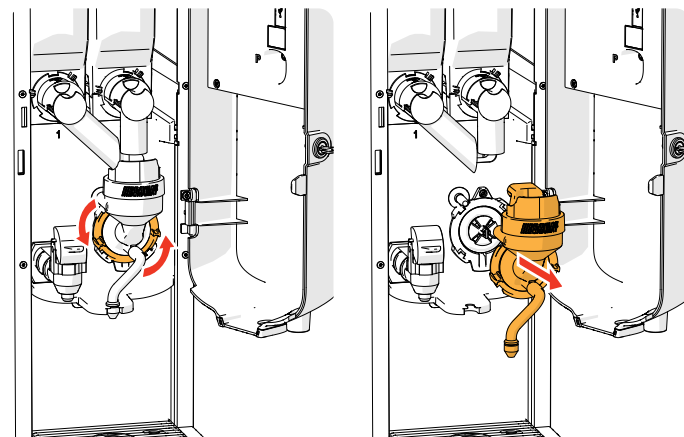

3. turn the fixation ring counter clockwise
4. remove the complete mixing system

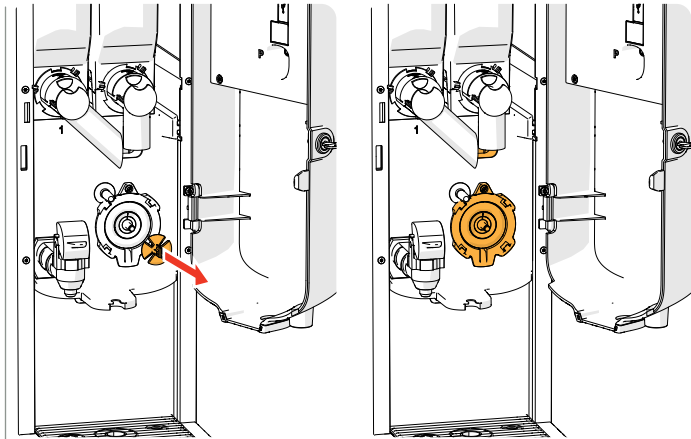

5. remove the mixer
6. clean the indicated parts, using a *damp* cloth

7. clean the removed parts (*not dishwasher proof*)
8. remount the mixing system in reverse order
  - Pay attention to the flat sides of the shaft and the mixer.
9. reconnect the hose to the mixing system and the outlet
10. replace the ingredient canister(s) in the correct position
11. open the "yellow" slider of the canister(s)
12. close the lid and door

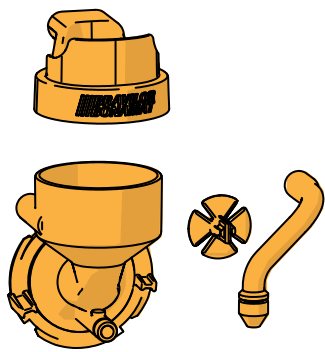

**The outside:**

1. switch off the machine (due to the touch screen)
2. clean the outside with a *damp* cloth
3. switch the machine back on

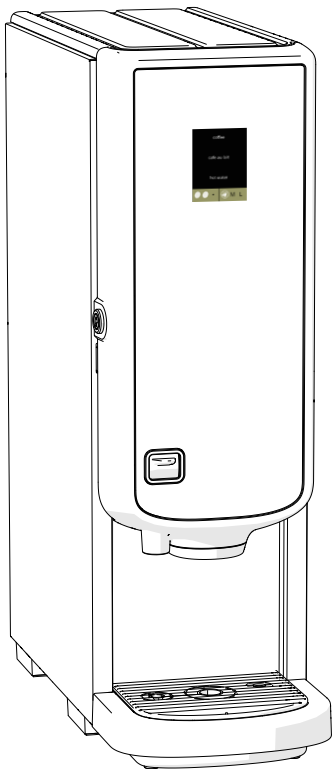

► To prevent clogging of ingredient that has fallen into the mixing system, it is recommended to rinse the machine after the daily cleaning procedure, see §5.1.1 on p.15.

## 4.2 Weekly cleaning

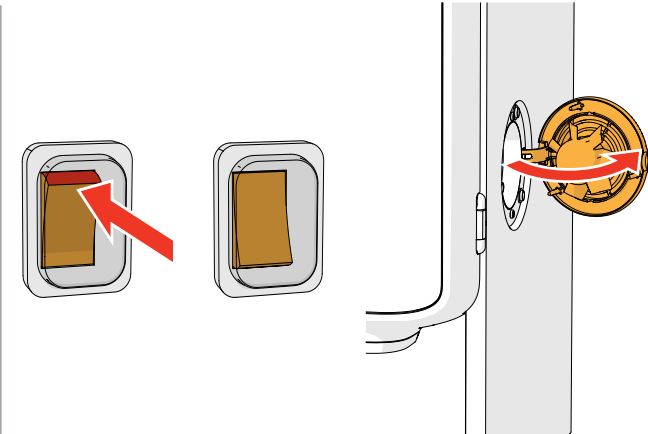

### Ventilation system:

1. switch off the machine
2. open the fan to the back

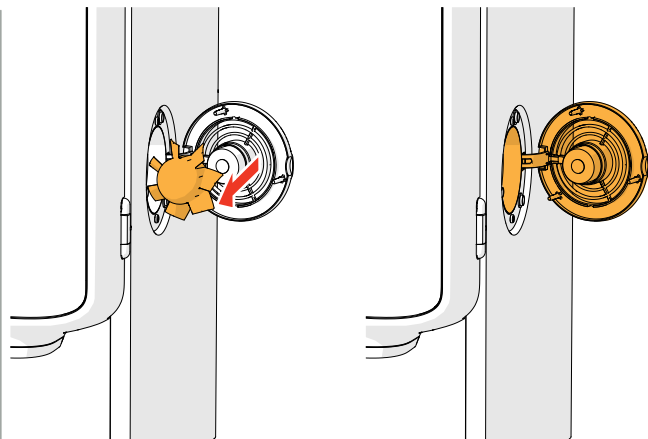

3. carefully pull the rotor of the motor
4. clean the fan housing and grid, using a *damp* cloth

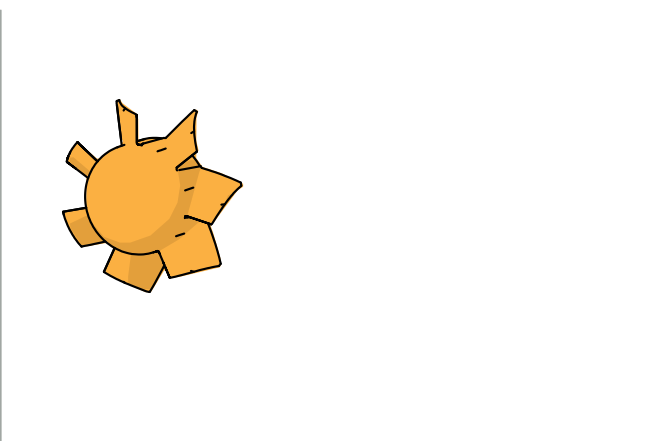

5. clean the fan rotor, using *hot soapy water*
6. dry everything and place the rotor back in place
7. switch the machine back on

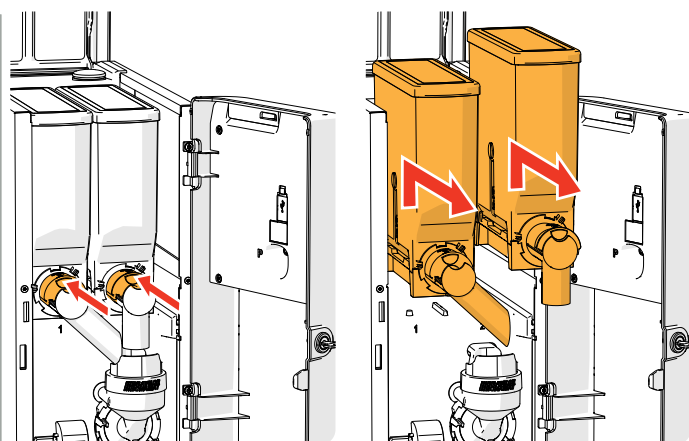

### Canister(s):

1. open the door and lid
2. close the canister outlet by moving the "yellow" slider to the back
3. take the canister(s) out of the machine

4. pour the ingredients in a dry bowl
5. unlink the outlet from the canister

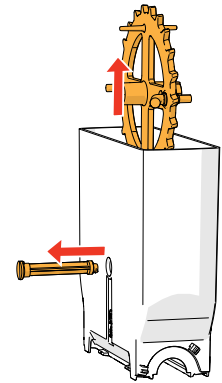
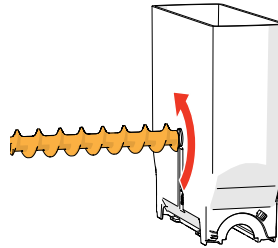
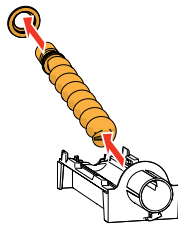
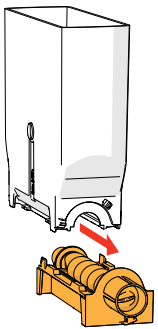
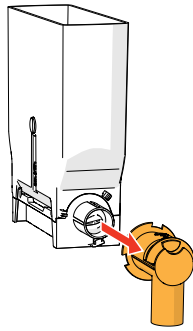
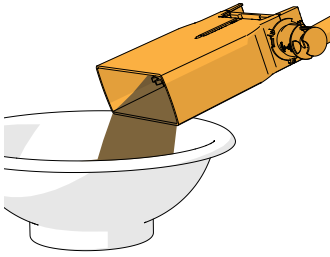

6. take apart the canister(s)
  7. clean the canister and outlet with a brush
- *Do not use water to prevent the ingredients from clumping and clogging the canister.*

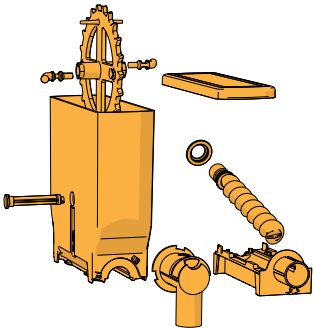

8. clean the inside of the machine with a damp cloth
9. refill the canister(s)
10. replace the canister(s) in its/their correct position
11. open the "yellow" slider of the canister(s)
12. close the lid and door

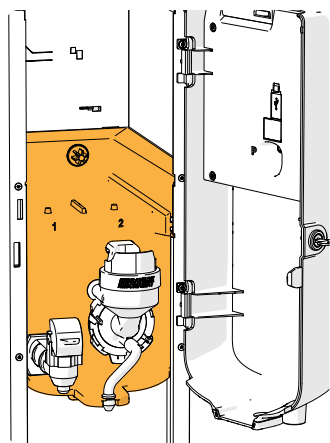

► *To prevent clogging of ingredient that has fallen into the mixing system, it is recommended to rinse the machine after the daily cleaning procedure, see §5.1.1 on p.15.*



## 5. Programming menu



To access the programming menu:

- open the door of the Bolero this message appears on the screen
- insert the service key (no. 7 on p.1)
- press the programming button (no. 9 on p.1)

► *All screen shots in this manual are in English.*

In the programming menu select one of the available options:

- press **◀** or **▶** to select the next option of the “programming menu”
- press the “text area” to select the next level for that menu
- press **✕** to exit the programming menu and return to the beverage selection menu.

► *If a PIN code is not set, all menu items are available.*

*If a PIN code is set, the user can enter the menu with or without a PIN code.*

*The menu items secured by PIN codes will be greyed out, see also §7.4 PIN code security settings on p.107.*

► *If no button is pressed within 5 minutes, the Bolero returns to the beverage selection screen.*

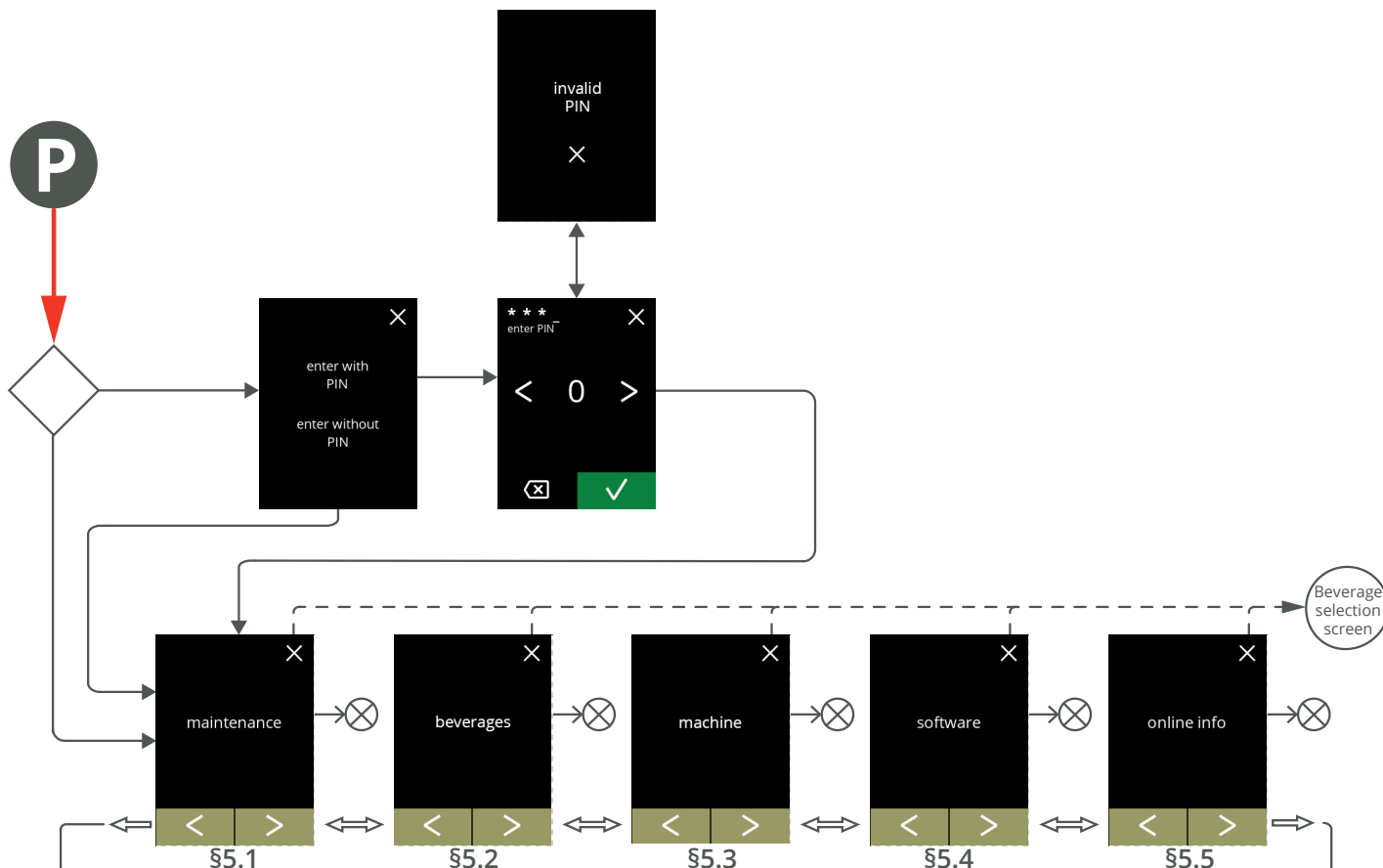

## 5.1 Maintenance menu

The maintenance menu contains all features that are available regarding the maintenance of the vending machine.

Select one of the available options:

- press **◀** or **▶** to choose the next option of the maintenance menu
- press the "text area" to select the next level for that menu
- press **⌂** to go back to chapter 5. Programming menu on p.13.

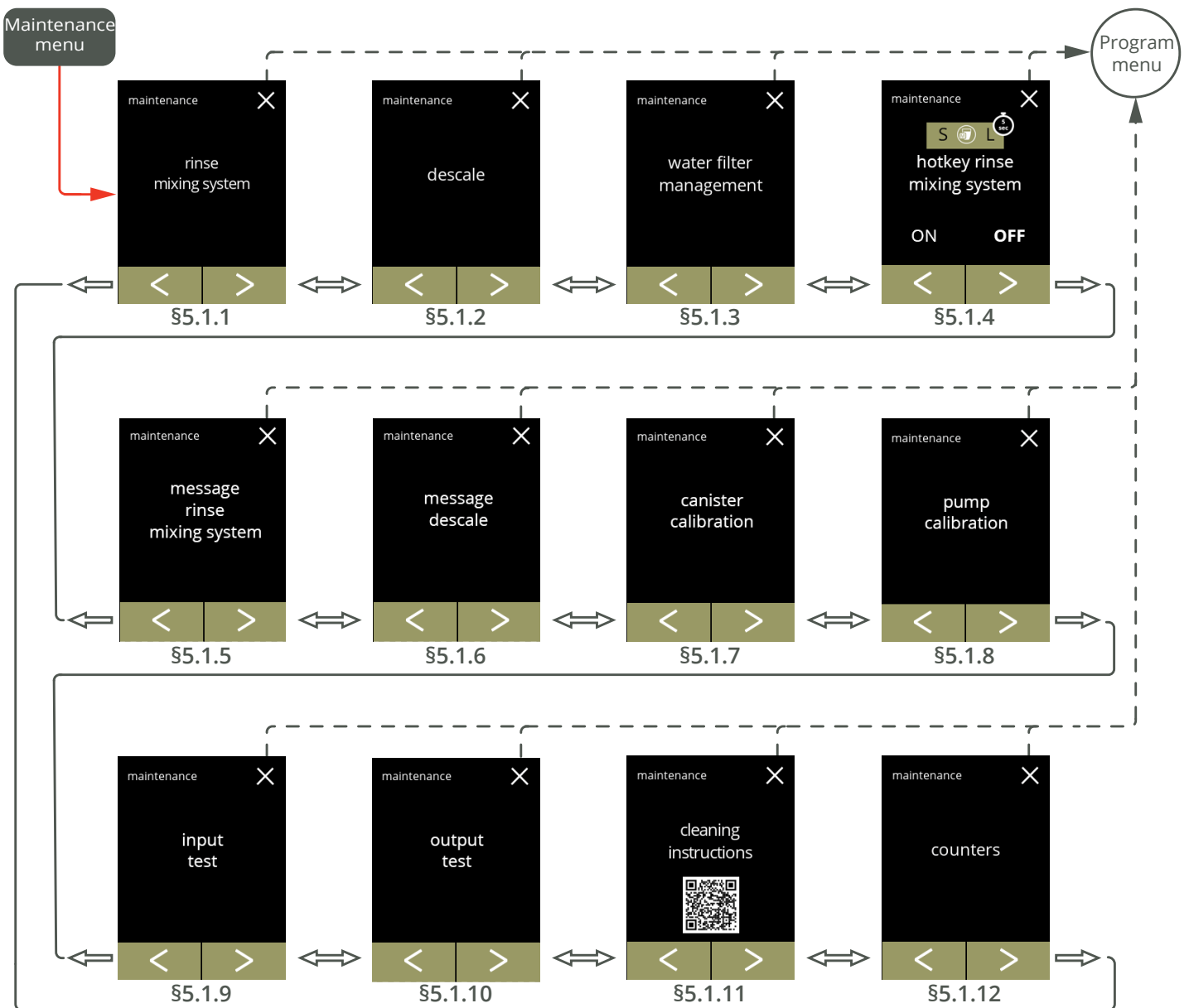

### 5.1.1 Rinse the mixing system

To maintain the correct functioning of the Bolero, the mixing system must be rinsed several times a day and cleaned daily, see §4.1 on p.9.

This procedure rinses the mixing system and the beverage hose.

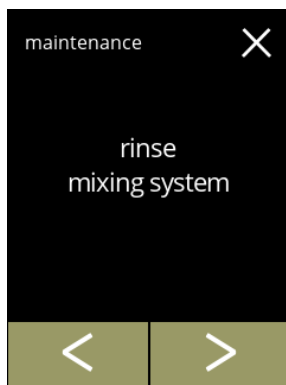

#### Necessities:

- container (0,5 litre)



5.1.1

The rinsing procedure:

- press "rinse mixing system" to select
- press  or  to scroll through the maintenance menu

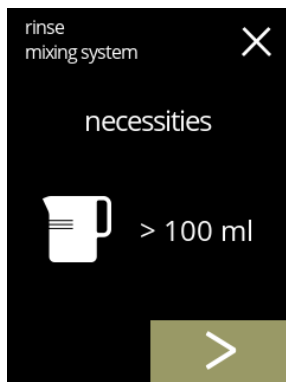

5.1.1a

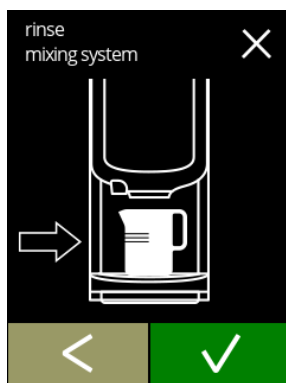

Information screen:

- make sure all necessities are available
- press  to go to the next screen



5.1.1b

Information screen:

- place an empty container under the beverage outlet
- press  to confirm
- press  to go to the previous screen

5.1.1c

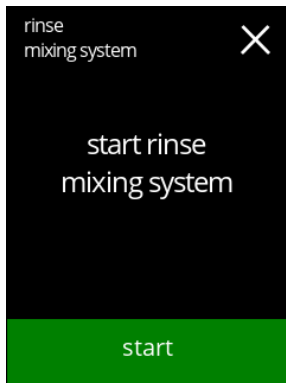

Start rinsing:

- press **start** to begin the rinsing

5.1.1d



Rinsing:

- wait until the process is finished
  - ▶ *Hot water from the outlet*
- press **cancel** to abort

5.1.1e



Information screens:

- screen 5.1.1 is displayed after a few seconds

### 5.1.2 Descale

Descaling the Bolero will remove all lime scale within the water system. This will extend the life-cycle of the Bolero.

**Necessities:**

- descale agent (recommended: "RENEGITE", our proven descaling agent)
- measuring jug (1 litre)
- funnel
- bucket (10 litre)
- average time: ± 40 minutes
- safety gloves and goggles

► *The descaling process must not be interrupted after screen 5.1.2c!*

The descaling procedure:

- press "descale" to select
- press ◀ or ▶ to scroll through the maintenance menu

5.1.2



5.1.2a



Preparation:

- make sure all necessities are available
- press ▶ to go to the next screen

5.1.2b

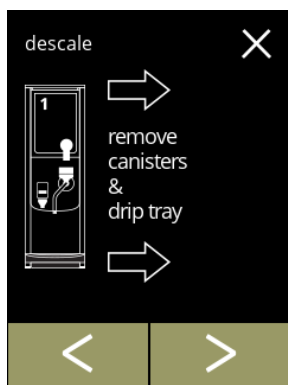



Preparation:

- follow the instructions on the screen
- press ▶ to go to the next screen
- press ◀ to go to the previous screen

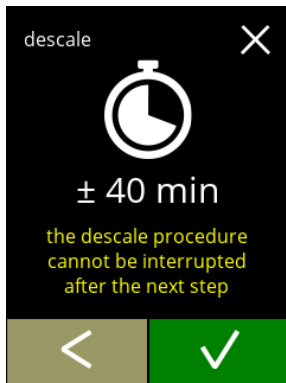
5.1.2c



Information screen:

- average time
  - press  to confirm and continue the descaling procedure
  - press  to go the previous screen
- ▶ *The descaling process cannot be interrupted after this screen!*

5.1.2d

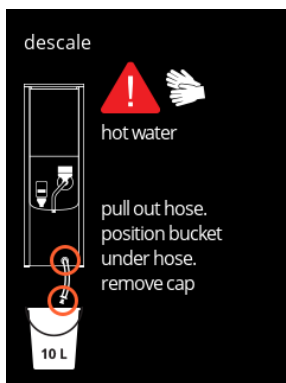

Drain the machine:

- follow the instructions on the screen
- ▶ *Wear protecting gloves, hot water!*
- when the water flows out of the hose, the following screen is displayed

5.1.2e

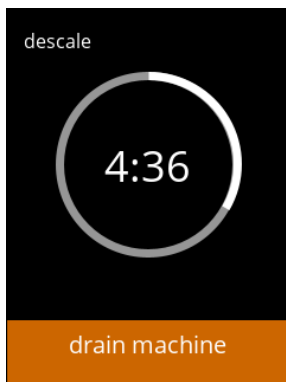

Draining the machine:

- time indication needed for draining
- when the boiler is empty, the following screen is displayed

5.1.2f

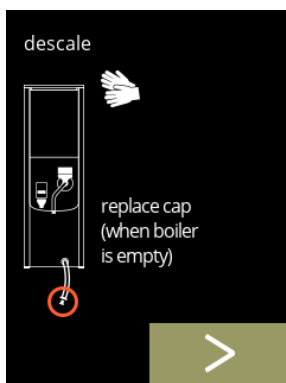

Close the hose:

- follow the instructions on the screen
- press  to go to the next screen

5.1.2g

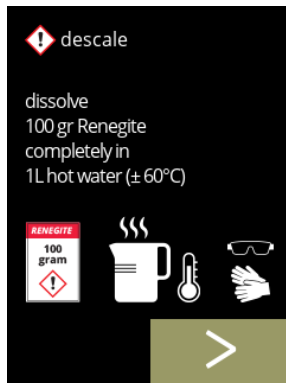

Prepare the descaling solution:

- follow the instructions on the screen
  - ▶ *Wear safety gloves and safety goggles.*
  - ▶ *The descaling agent must be dissolved completely.*
- press **>** to go to the next screen

5.1.2h

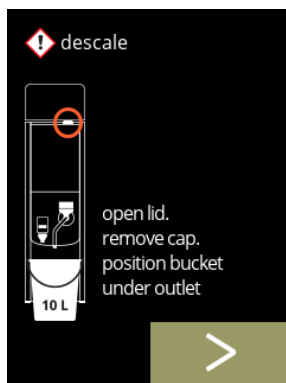

Preparation:

- follow the instructions on the screen
- press **>** to go to the next screen
  - ▶ *Place the bucket also under **all** the outlets (including the hot water outlet).*

5.1.2i



Preparation:

- follow the instructions on the screen
- press **>** to go to the next screen
  - ▶ *Wear safety gloves and safety goggles.*
  - ▶ *Do not leave the machine unattended while a descaling solution is in the machine.*

5.1.2j



Start descaling:

- press **start** to begin the descaling

Descaling:

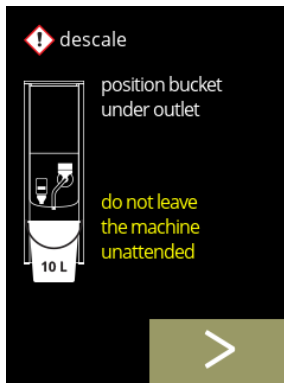

5.1.2k

► *Make sure that the bucket is placed under the outlets, in the next step, water with descaling solution will come out of **all** the outlets (including the hot water outlet).*

- press  to go to the next screen

Descaling:

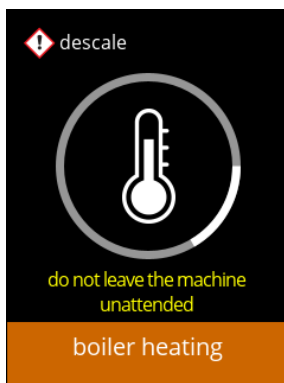

5.1.2l

- the boiler is heating up, wait for the next screen

Descaling:

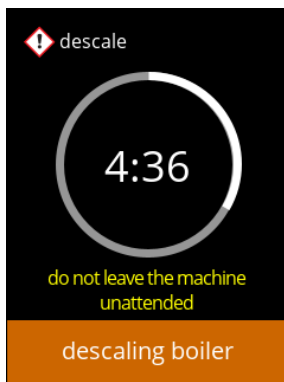

5.1.2m

- when the timer has expired the next screen appears and hot water with descaling solution comes out of the outlets

Descaling - warning screen:

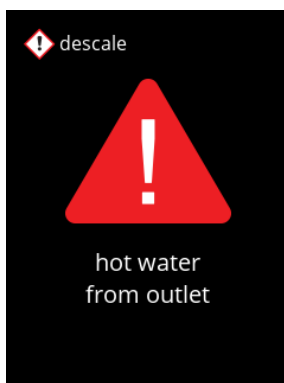

5.1.2n

- wait for the next screen

► *Hot water with descaling solution will come out of the outlets.*



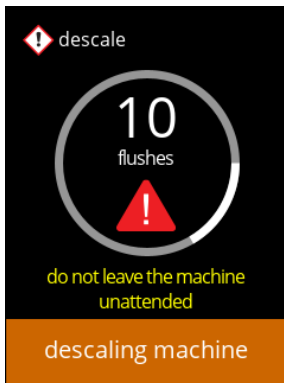

5.1.2o

Descaling:

- wait for the next screen

► *Hot water with descaling solution flows out **all** of the outlets.*



5.1.2p

Descaling - draining:

- follow the instructions on the screen

► *Wear safety gloves and safety goggles, the water is hot and contains descaling solution!!*

- when the water flows out of the hose, the next screen is displayed

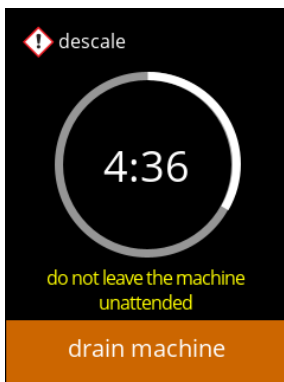

5.1.2q

Descaling - draining:

- time indication needed for draining

- when the boiler is empty, the next screen is displayed

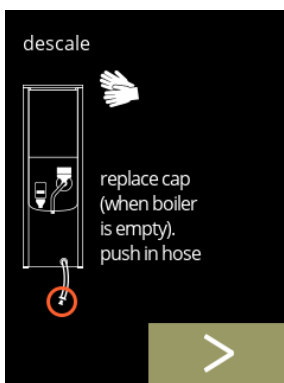

5.1.2r

Descaling - draining:

- follow the instructions on the screen

- press  to go to the next screen

► *Remove and empty the bucket.*

5.1.2s

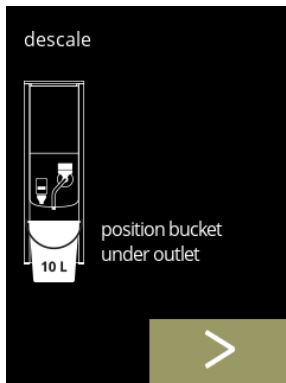

Descaling - rinse:

- follow the instructions on the screen
  - ▶ Use an empty bucket.
  - ▶ Place the bucket also under **all** the outlets (including the hot water outlet).
- press > to go to the next screen

5.1.2t

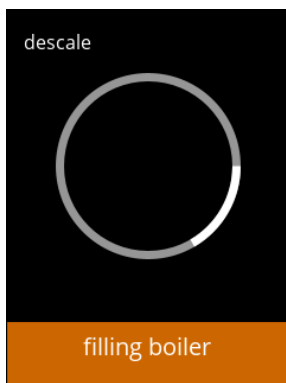

Descaling - rinse:

- the boiler is filling, wait for the next screen

5.1.2u



Descaling - rinse warning screen:

- wait for the next screen
  - ▶ Water will come out of **all** the outlets.

5.1.2v

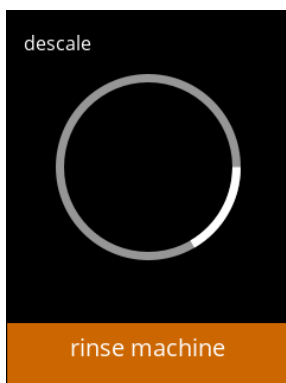

Descaling - rinsing:

- wait for the next screen

5.1.2w

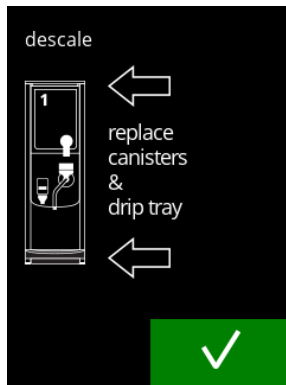

Descaling - ending:

- follow the instructions on the screen
- press  to confirm every things has been restored

5.1.2x



Information screens:

- screen 5.1.2 is displayed after a few seconds

5.1.2y



Warning screen interrupted descaling process:

- press  to continue the procedure where it was interrupted and to finish the descaling process

### 5.1.3 Water filter management



If a water filter is installed, replaced or removed must be confirmed in the software so that the counter is updated. A water filter lessens lime-scale deposits and reduces impurities in the water. The Bolero also does not need to be descaled so often, see §7.1 on p.106. Additionally, it ensures a consistent quality of the hot beverage in both taste and aroma.

water filter settings	default	minimum	maximum
capacity (litre)	<i>OFF</i>	100	10000
months shelf life		1	24

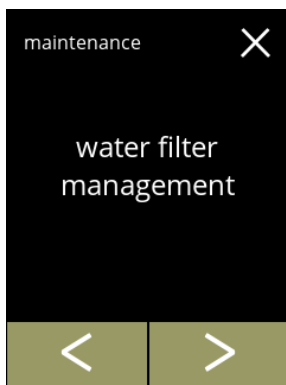
5.1.3



Install, replace or remove the water filter:

- press *"water filter management"* to select
  - » water filter **already** installed go to screen 5.1.3c
  - » water filter **not yet** installed, go to the next screen
- press  or  to scroll through the maintenance menu

5.1.3a

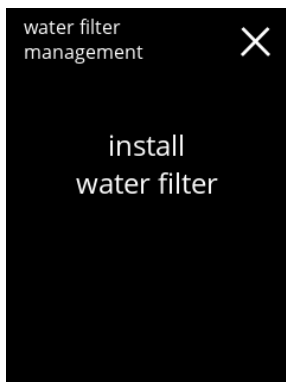

Installing:

- press *"install water filter"* to select
  - ▶ *Read the instructions that come with the filter.*

5.1.3b

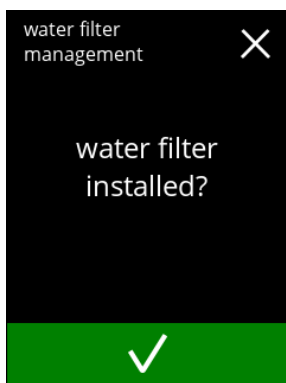

Confirmation screen:

- install the water filter (conform its instructions)
- press  to confirm and go to screen 5.1.3f

5.1.3c

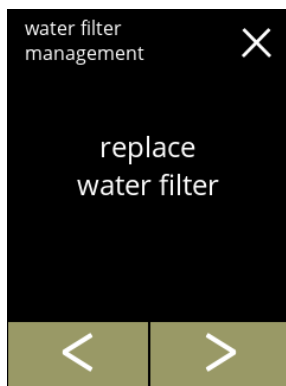

Replacing:

- press *"replace water filter"* to select
- press **◀** or **▶** to scroll through the water filter sub-menu
  - » water filter settings (5.1.3e)
  - » uninstall water filter (5.1.3h)

5.1.3d

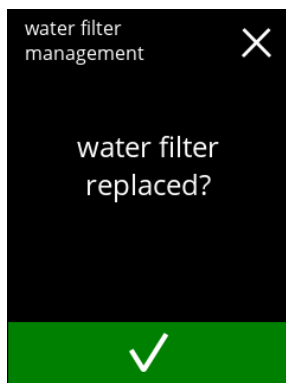

Replace the water filter (according to its own instructions).

- press **✓** to confirm and go to screen 5.1.3f

5.1.3e

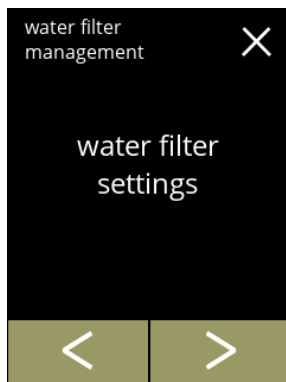

Set notification:

- press *"water filter settings"* to select and go to the next screen
- press **◀** or **▶** to scroll through the water filter sub-menu
  - » uninstall water filter (5.1.3h)
  - » replace water filter (5.1.3c)

5.1.3f

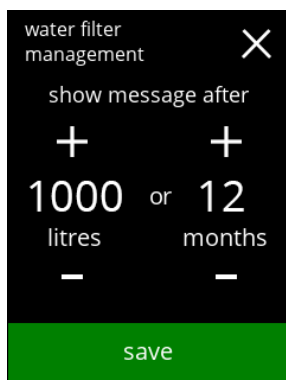

Set the 'replace water filter' message:

- ▶ *When the water filter is first installed, both values start at 0 and must be changed before **save** is displayed.*
- ▶ *When replacing a water filter, the previous values are set and **save** is displayed immediately.*
- adjust the settings
  - ▶ *Both values are required*
- press **save** to confirm

Information screens:

- screen 5.1.3 is displayed after a few seconds

5.1.3g

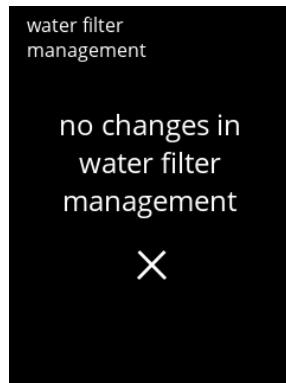
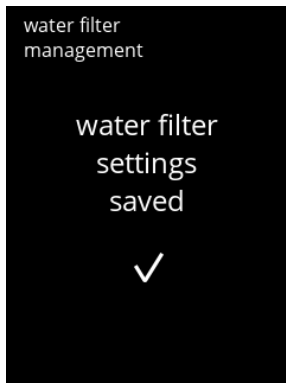

5.1.3h

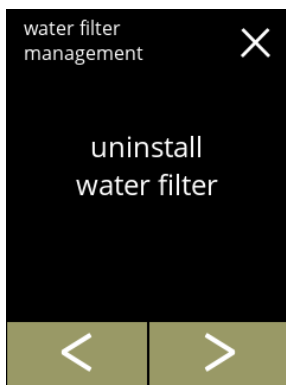

Permanent removal:

- press *"uninstall water filter"* to select and go to the next screen
- press **◀** or **▶** to scroll through the water filter sub-menu
  - » replace water filter (5.1.3c)
  - » water filter settings (5.1.3e)

5.1.3i

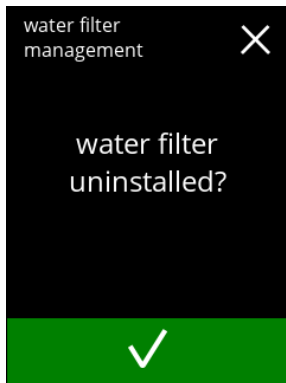

Uninstall the water filter:

- physically remove the water filter
- press **save** to confirm

5.1.3j

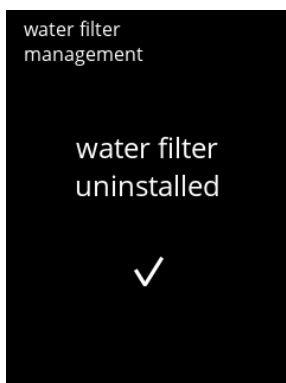

Information screen:

- screen 5.1.3 is displayed after a few seconds

### 5.1.4 Hot-key rinsing function

To prevent clogging, it is necessary to rinse the mixing system several times a day.

For this purpose, it is possible to set up a so-called hot-key on the screen.

In this menu it is possible to put the hot-key rinsing function active or inactive in the beverage selection screen.

**Default: OFF**

- ▶ To use the hot-key rinsing function press and hold for five seconds the S M L button on the beverage selection screen, the rinsing of the mixing system starts immediately.

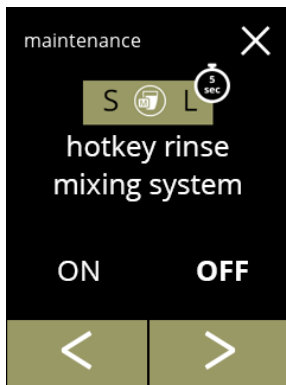

5.1.4

Availability of hot-key:

- press "ON" to make the hot-key visible
- press ◀ or ▶ to scroll through the maintenance menu

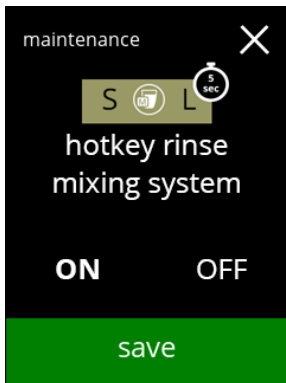

5.1.4a

Setting the hot-key:

- press **save** to confirm
- ▶ *Save is only active if something has changed.*

### 5.1.5 Cleaning management

In this menu, it is possible to set a time for a cup counter to display a warning before rinsing the machine.

The warning can always be cancelled without rinsing the machine.

**Default: OFF**

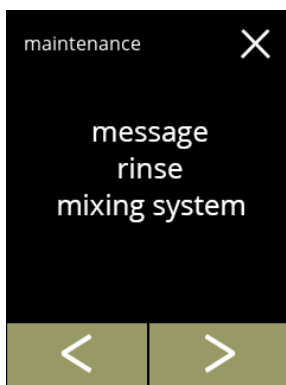

5.1.5

Cleaning management

- press "message rinse mixing system" to select
- press ◀ or ▶ to scroll through the maintenance menu

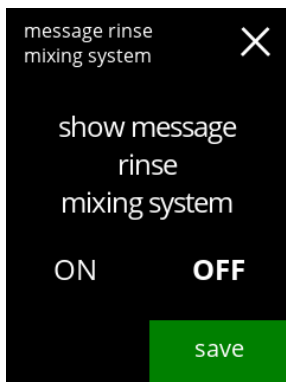

5.1.5a

Setting rinse message:

- press 'ON' or 'OFF' to set the message
  - » select OFF and **save**;
  - go to the next screen
  - » select ON and **✓**;
  - next screen is 5.1.5c



5.1.5b

Information screen:

- screen 5.1.5 is displayed after a few seconds



5.1.5c

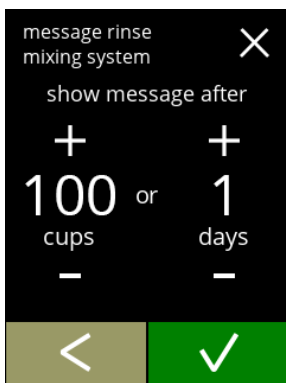

Set day or time:

- press **+** or **-** to set the number of cups or days after which the warning should pop-up
- press **✓** to confirm and go to the next screen
- press **←** to go back to screen 5.1.5a

5.1.5d

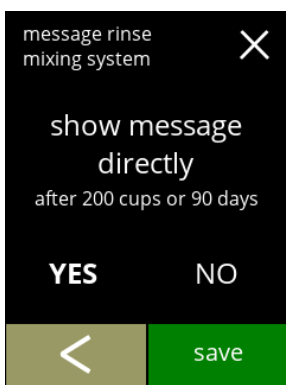

Message direct or at a later time:

- press "YES" or "NO" to set the message timing
  - » select YES and **save**:
  - go to the second screen of 5.1.5f
  - » select NO and **✓**:
  - go to the next screen
- press **←** to go to the previous screen

5.1.5e

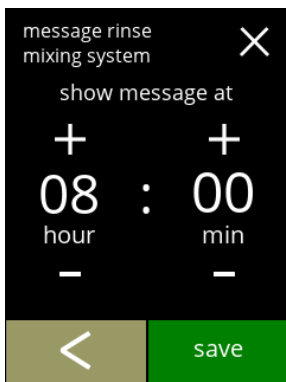

Set the timer:

- press **+** or **-** to set the hour and minutes
- press **save** to confirm and go to the first screen of 5.1.5f
- press **←** to go to the previous screen

5.1.5f

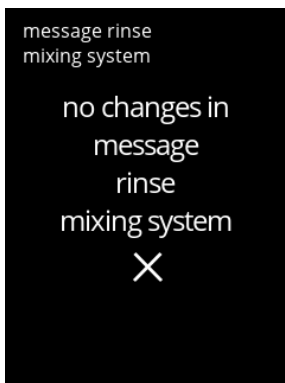

Information screens:

- screen 5.1.5 is displayed after a few seconds

## 5.1.6 Descale management

It is important to know the correct hardness of the water at the location where the Bolero is used (for setting the descaling signal).  
If necessary, ask the local water company for the hardness of the water supplied or measure the hardness of the water supplied on site with a water hardness tester (according to the corresponding instructions).

**Default: ON (with average water hardness)**

See also §7.1 Filter information and water hardness on p.106.

5.1.6

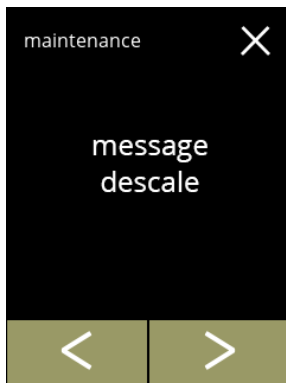

Descale management

- press "descale management" to confirm
- press ◀ or ▶ to scroll through the maintenance menu

5.1.6a

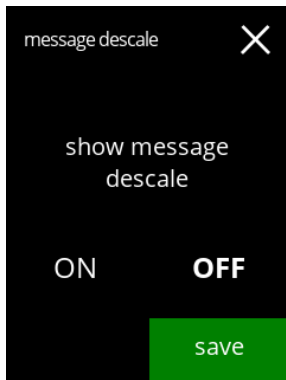

Descale message:

- press "ON" or "OFF" to set the message
  - » select OFF and **save**;
  - go to the next screen
  - » select ON and **✓**;
  - go to screen 5.1.6c

5.1.6b



Information screen:

- screen 5.1.6 is displayed after a few seconds

5.1.6c

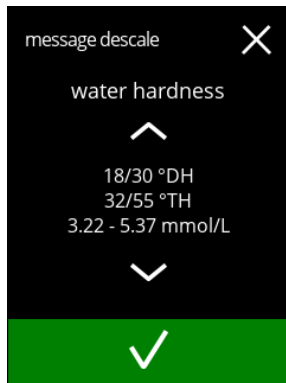
**Water hardness:**

- press or to set the water hardness
  - ▶ *When a water filter is used, the message can be delayed, select 0-4 °DH.*
    - » select a value between 4/8 and 18/30 °DH; press to confirm and go to screen 5.1.6g
    - » select 0/4 °DH; press to confirm and go to the next screen

5.1.6d

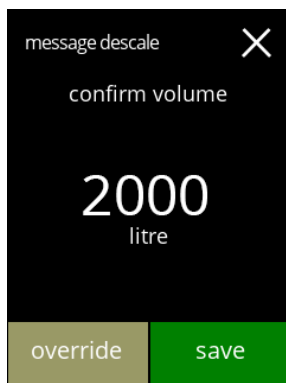
**Volume override:**

- press to confirm and go to screen 5.1.6h
- press to adjust the volume for the notification and go to the next screen
  - ▶ *When a water filter is used the volume can be adjusted.*

5.1.6e

**Increase maximum standard volume:**

- press or to set the volume
- press to confirm and go to the next screen
- press to go to the previous screen
  - ▶ *The override volume is shown in orange and can be set from 2100 till 9999 litre.*
  - ▶ *If used incorrectly, the descale message can be delayed for too long, allowing lime-scale to build up.*

5.1.6f

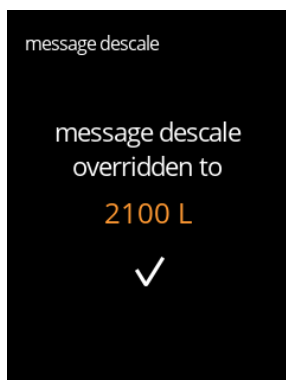
**Information screen:**

- screen 5.1.6 is displayed after a few seconds

Standard volumes/water hardness:

- press **save** to confirm and go to the next screen

5.1.6g

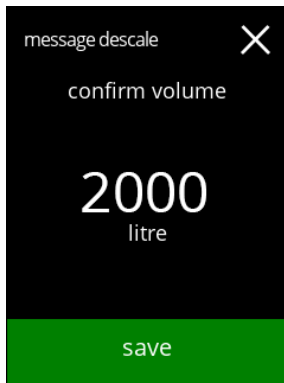

Information screen:

- screen 5.1.6 is displayed after a few seconds

5.1.6h



### 5.1.7 Canister calibration

In this menu the canisters can be calibrated.



The calibration determines the quantity of the ingredient when a canister motor runs at a defined speed for a defined time.

When finished the measured weight must be filled in.

#### Necessities:

- empty cup
- precision scale

Canister calibration procedure:

- press "canister calibration" to confirm
- press  or  to scroll through the maintenance menu

5.1.7

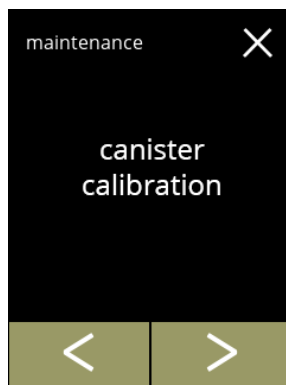

Make sure all necessities are available.



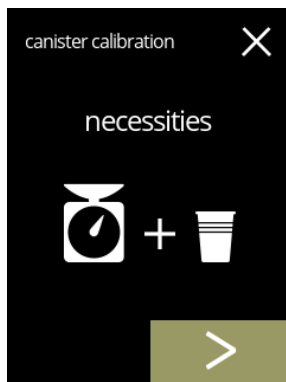

- press  to go to the next screen

5.1.7a



Canister selection:

- ▶ *The number of canisters may vary per configuration, see §7.3 on p.106.*

- press  or  to select a canister (if more than one)
- press  to confirm and go to the next screen
- press  to go to the next screen
- press  to go to the previous screen

5.1.7b

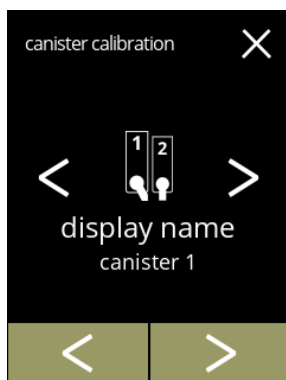

5.1.7c



Information screen:

- turn the fixation ring counter-clockwise
- remove the mixing system
- put an *empty dry* cup under the canister outlet
- press **start** to begin the pre-calibration dosing
- press **<** to the previous screen

5.1.7d

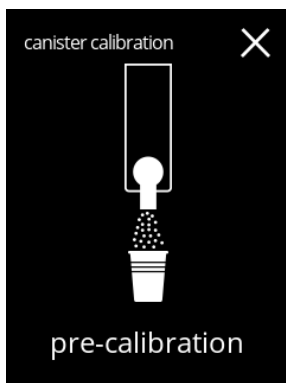

Pre-calibration dosing:

- wait for the next screen
- ▶ *The canister motor will turn to fill up the outlet.*

5.1.7e

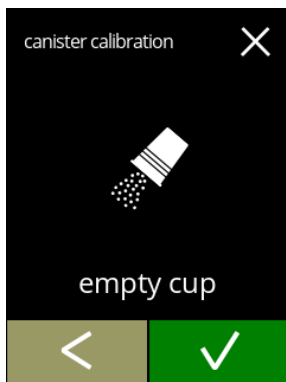

Pre-calibration dosing:

- throw the collected ingredient back into the canister
- press **✓** to confirm and go to the next screen
- press **<** to go back to screen 5.1.7c

5.1.7f

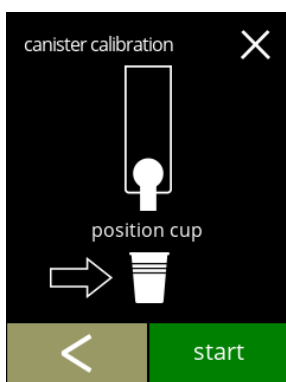

Actual calibration:

- put a *empty dry* cup on the precision scale to calibrate
- put the cup under the canister outlet
- press **start** to begin the dosing
- press **<** to the previous screen

5.1.7g

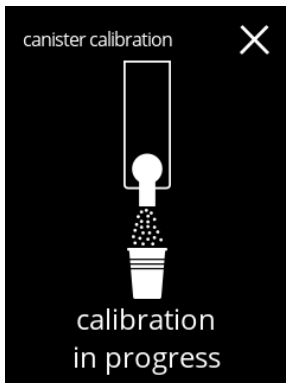

Dosing:

- wait for the next screen
- ▶ *The canister motor starts and stops several times.*

5.1.7h

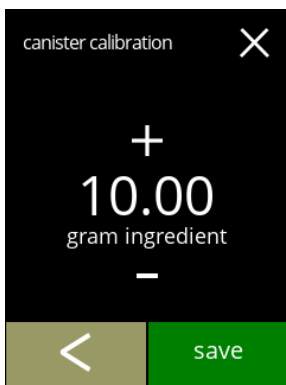

Weighing the ingredient:

- put the cup with ingredient on the balance
- press **+** or **-** to enter the weight on the screen
- press **save** to confirm and go to the next screen
- press **←** to go back to screen 5.1.7e

5.1.7i

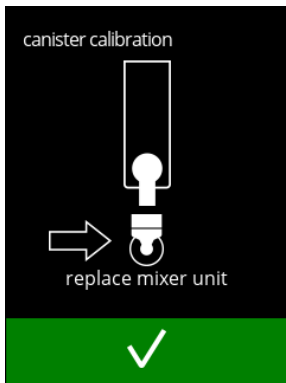

Calibration completed:

- put the mixing system back in place
- press **✓** to confirm

5.1.7j

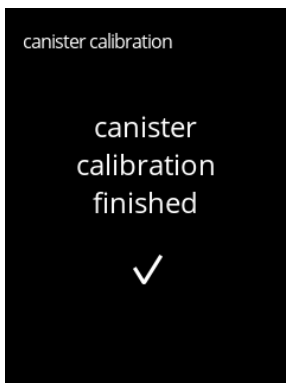

Information screens:

- screen 5.1.7 is displayed after a few seconds

### 5.1.8 Pump calibration

In this menu the pump can be calibrated.

With calibration the volume of the water is determined for a defined flow and time.  
When finished the measured volume must be filled in.

#### Necessities:

- measuring jug (minimal 200 ml)

5.1.8

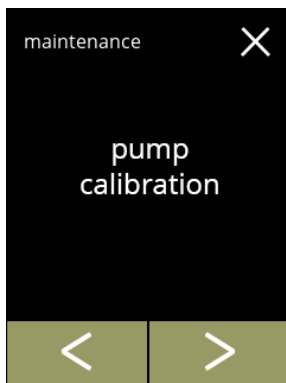

Pump calibration procedure:

- press "pump calibration" to confirm
- press ◀ or ▶ to scroll through the maintenance menu

5.1.8a

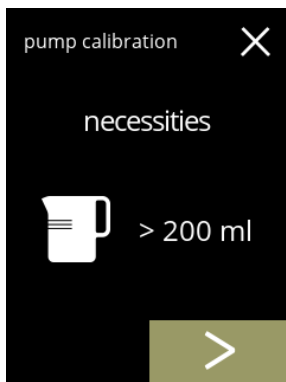

Make sure all necessities are available.

- press ▶ to confirm and go to the next screen

5.1.8b

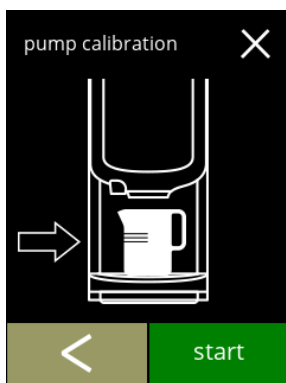

Information screen:

- put a *empty* measuring jug under beverage outlet
- press **start** to begin the dosing
  - ▶ *Please note the machine dispenses hot water.*
- press ◀ to go to the previous screen



5.1.8c

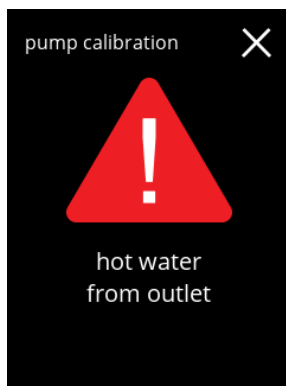

Warning screen:

- ▶ *The warning screen is displayed for a few seconds.*
- please wait until the next screen

5.1.8d

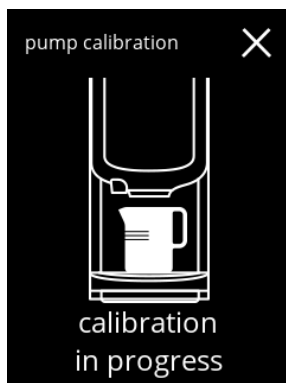

Hot water dosing in progress:

- wait until the next screen appears
- ▶ *Hot water from outlet.*

5.1.8e

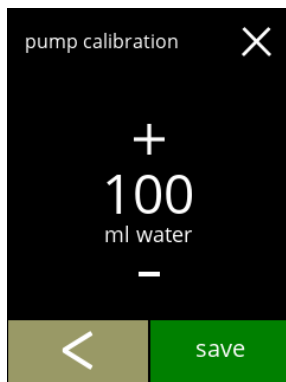

Determine volume:

- read off the amount of water dosed
- press **+** or **-** to enter the volume on the screen
- press **save** to confirm and go to the next screen
- press **<** to go back to screen 5.1.8b

5.1.8f

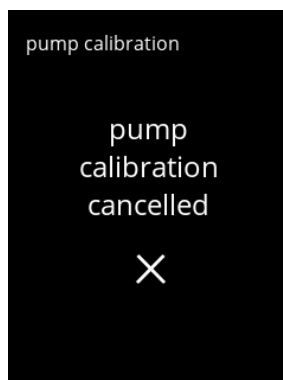
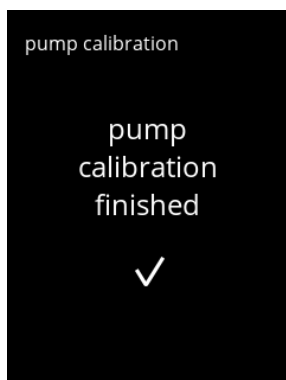

Information screens:

- screen 5.1.8 is displayed after a few seconds

### 5.1.9 Input test

For a proper fault analysis a diagnosis should be made first.  
An input test can be performed for the following components:

- touchscreen
- floater
- NTC1 (low position) and NTC2 (high position)
- door switch / safety key
- low pressure pump

► *Despite the fact that sufficient safety measures are taken working with the systems may entail risks. Our starting point is that people activating this menu are sufficiently skilled and therefore able to properly assess these risks with respect to safety.*

5.1.9

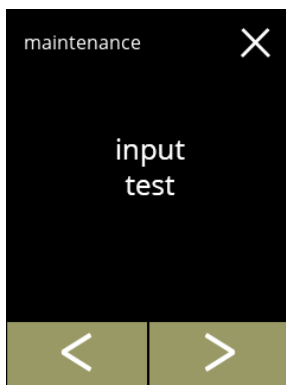

Input test

- press "input test" to confirm
- press ◀ or ▶ to scroll through the maintenance menu

5.1.9a

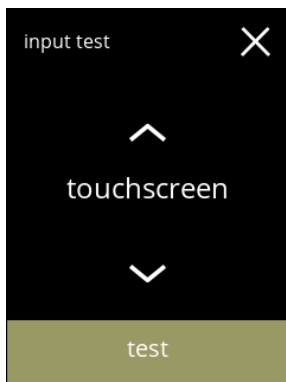

Select an input test:

- press test to go to the next screen
- press ▲ or ▼ to select another component

5.1.9b

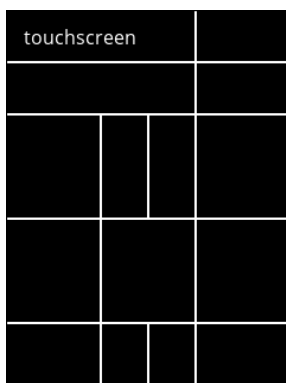



Touch screen:

- touch the areas, they turn green if the button works (touch it again and it turns black again)
- *If not all blocks are tested within 20 seconds, the machine returns to the previous screen. Next time, the previously tested blocks are still green. This screen will not start a full black screen until all blocks are green (OK tested).*

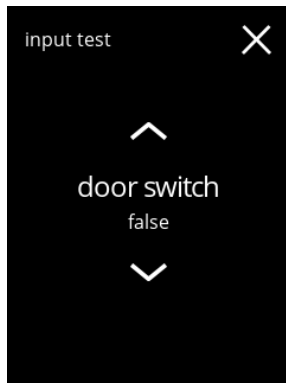
5.1.9c





Door switch/safety key:

- remove the service key and replace it resulting in false/true
- press  or  to select another component

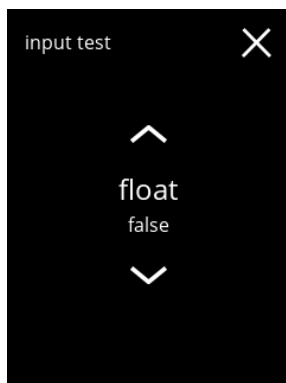
5.1.9d





Float:

- shows current state on screen (true=wet or false=dry)
- press  or  to select another component

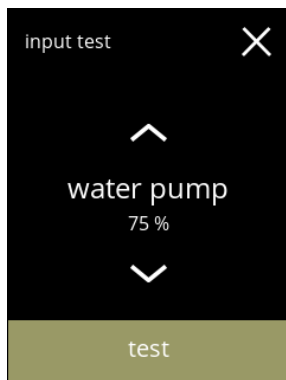
5.1.9e



Low pressure pump:

- shows current state of the sensor on screen (true or false)
- press  to go to the next screen
- press  or  to select another component

5.1.9f

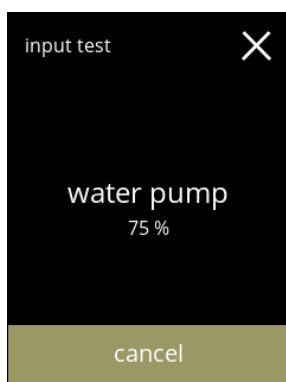



Test the low pressure pump:

- the low pressure pump is turned on for 10 seconds and then stops.
  - ▶ *The motor runs slowly, so no water will come out of the outlet.*
- press  to go back to previous screen

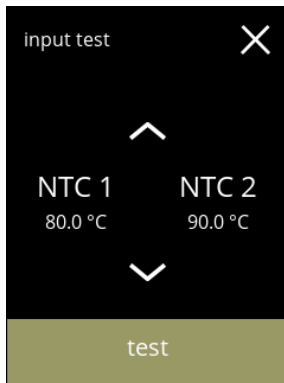
5.1.9g



NTC sensors:

- shows current temperature on screen
- press **test** to go to the next screen
- press  or  to select another component

5.1.9h

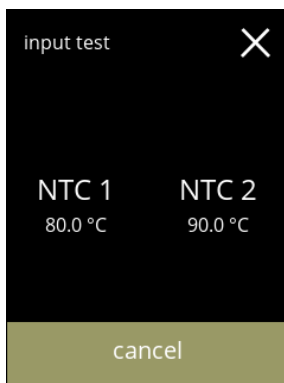

Test the NTC sensors:

- ▶ *The heating element is on for 10 seconds, so the temperature on the screen should rise.*
- press **cancel** to go back to previous screen

### 5.1.10 Output test

For a proper fault analysis a diagnoses should be made first.

The output test gives an overview of all parts able to deliver signals (electrical components).  
Components that can be tested:

- buzzer
- canister(s)
- mixer motor
- low pressure pump
- heating element
- magnetic inlet valve
- fan motor

► *Despite the fact that sufficient safety measures are taken working with the systems may entail risks. Our starting point is that people activating this menu are sufficiently skilled and therefore able to properly assess these risks with respect to safety.*

5.1.10

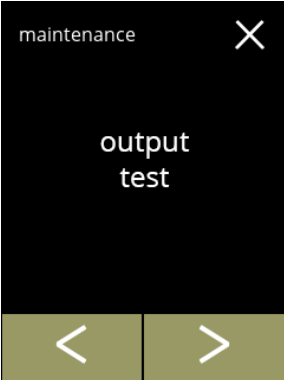

Output test

- press "output test" to confirm
- *There are two options for testing:*
  - » pulse: the action is executed as long as the button is pressed.
  - » cycle: the action is executed for 10 seconds and press on **cancel** to interrupt.
- press **<** or **>** to scroll through the maintenance menu

5.1.10a



Buzzer test:

- press **pulse**,  
result: short 'beep'
- press **cycle**,
- result: multiple short 'beeps'
- press **⏏** or **✔** to select another component

5.1.10b

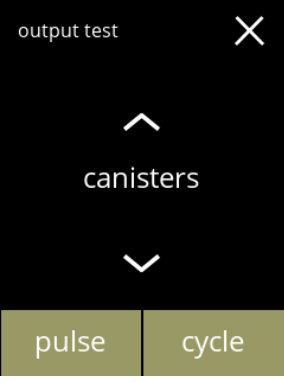

Canister motor test **Bolero 11:**

- remove the canister
- press **pulse**,  
result: the canister motor runs briefly at 20% speed
- press **cycle**,
- result: the canister motor runs at 20% speed for 10 seconds
- press **⏏** or **✔** to select another component

5.1.10c

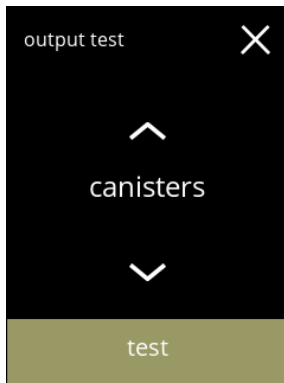

Canister motor test **Bolero 21:**

- press **test** to select a canister in the next screen
- press **▲** or **▼** to select another component

5.1.10d

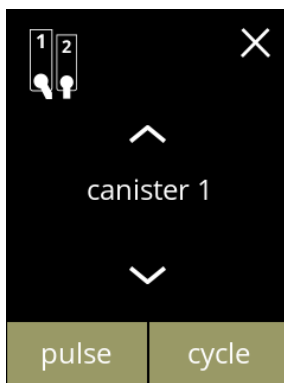

Canister motor test **Bolero 21:**

- remove the canister(s)
- press **pulse**,  
result: the canister motor runs briefly at 20% speed
- press **cycle**,  
result: the canister motor runs at 20% speed for 10 seconds
- press **▲** or **▼** to select another canister

5.1.10e

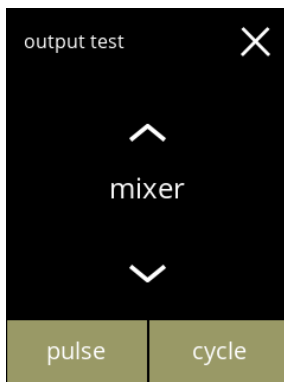

Mixer motor test:

- press **pulse**,  
result: the mixer motor runs briefly at full speed
- press **cycle**,  
result: the mixer motor runs at full speed for 10 seconds
- press **▲** or **▼** to select another mixer

5.1.10f

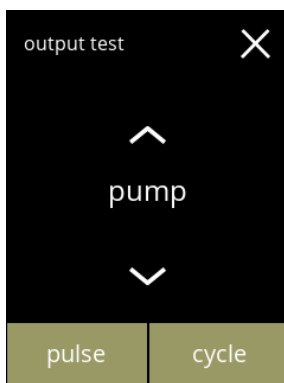

Low pressure pump test:

- press **pulse**,  
result: the pump motor runs briefly
- press **cycle**,  
result: the pump motor runs for 10 seconds
- ▶ *The water will not reach the mixing system.*
- press **▲** or **▼** to select another component

5.1.10g

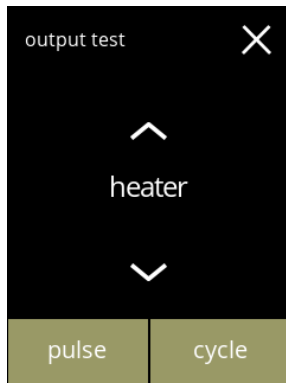

Heating element test:

- press **pulse**,  
result: the heating element turns on for a moment
- press **cycle**,  
result: the heating element turns on for 10 seconds
- press **▲** or **▼** to select another component

5.1.10h

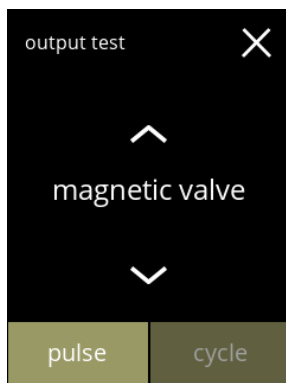

Magnetic inlet valve test:

- press **pulse**,  
result: the valve opens for a moment
- ▶ *Do **not** perform the pulse test several times in a row, as this can lead to an overflow of the float tank, for this reason the cycle button is not accessible.*
- press **▲** or **▼** to select another component

5.1.10i

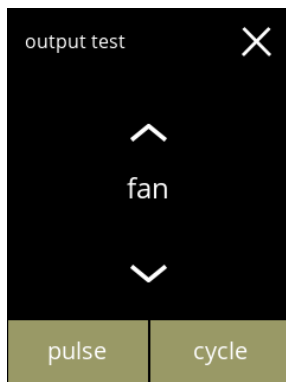

Fan motor test:

- press **pulse**,  
result: the fan motor runs briefly at full speed
- press **cycle**,  
result: the fan motor runs at full speed for 10 seconds
- press **▲** or **▼** to select another component

### 5.1.11 Cleaning instructions

To maintain proper functioning, the Bolero must be cleaned regularly.

daily	weekly
drip tray	canister(s)
mixing system	ventilation system
the outside	the inside

► The cleaning instructions are also available as an animation by scanning the QR code in this menu.

► See also chapter 4. Cleaning on p.9 for a detailed description.

5.1.11

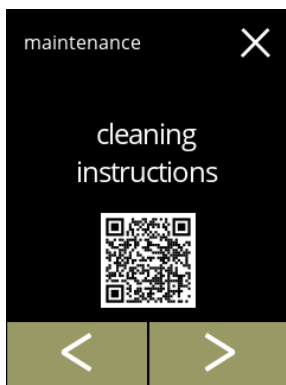

Cleaning instructions:

- press "cleaning instructions" to confirm
- press ◀ or ▶ to scroll through the maintenance menu

5.1.11a

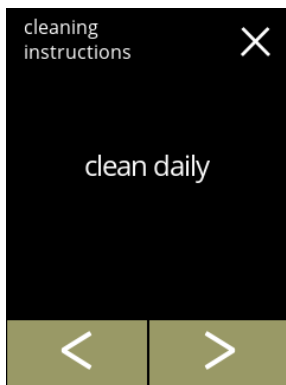

Daily cleaning instructions:

- press "clean daily" to go to the next screen
- For detailed instruction see §4.1 on p.9.
- press ◀ or ▶ to go to weekly cleaning (5.1.11e)

5.1.11b

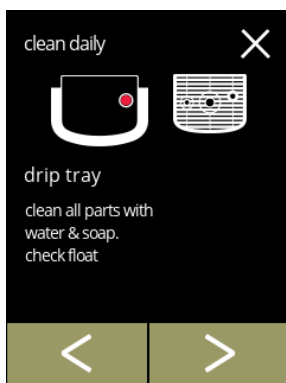

Cleaning the drip tray:

- follow the instructions on the screen
- press ◀ or ▶ to select another daily cleaning instruction



5.1.11c



Cleaning the mixing systems:

- follow the instructions on the screen
- press ◀ or ▶ to select another daily cleaning instruction

5.1.11d



Cleaning the outside:

- follow the instructions on the screen
- press ◀ or ▶ to select another weekly cleaning instruction

5.1.11e

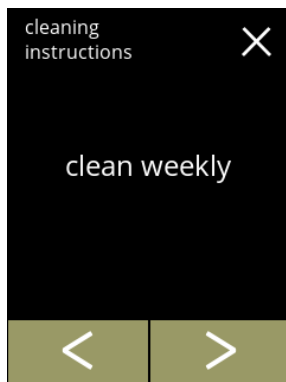

Weekly cleaning instructions:

- press "clean weekly" to go to the next screen
  - ▶ *For detailed instruction see §4.2 on p.11.*
- press ◀ or ▶ to go to daily cleaning (5.1.11a)

5.1.11f

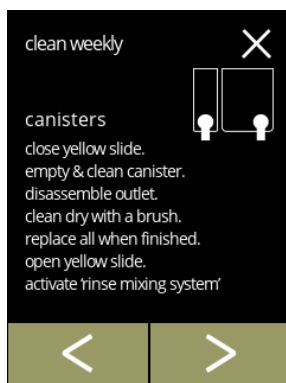

Cleaning the canisters:

- follow the instructions on the screen
- press ◀ or ▶ to select another weekly cleaning instruction



5.1.11g

Cleaning the fan:

- follow the instructions on the screen
- press ◀ or ▶ to select another weekly cleaning instruction

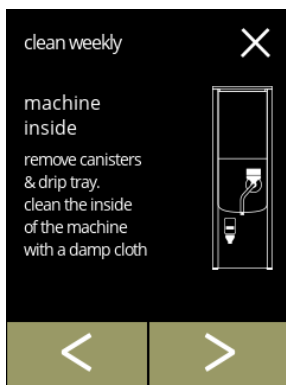

5.1.11h

Cleaning the inside:

- follow the instructions on the screen
- press ◀ or ▶ to select another weekly cleaning instruction

## 5.1.12 Counters

The counters tell you how many beverages have been prepared.

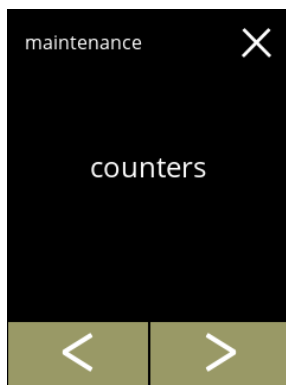

A total counter of all issued beverages is also displayed.

If a drink is removed, the number of that beverage is still counted in the total machine counter.



5.1.12

Counters readings:

- press "counters" to confirm
- press  or  to scroll through the maintenance menu

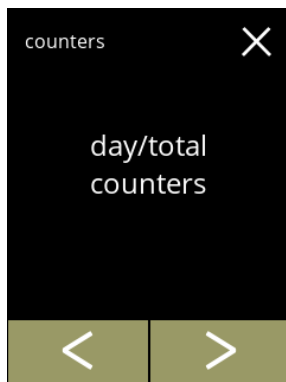

► *The counters sub-menu consists of the following:*

- » day/total counters 5.1.12a
- » reset day counters 5.1.12c
- » reset all counters 5.1.12g
- » export counters 5.1.12k
- » machine counters 5.1.12o



5.1.12a

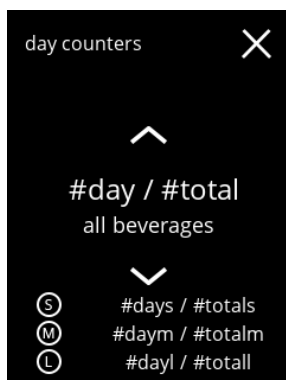

Day counters:

- press "day/total counters" to confirm
- press  or  to scroll through the counters sub-menu



5.1.12b

Day counters per beverage and the total of all beverages:

- press  or  to scroll through all available beverages
- press  to go the previous screen

Reset all day counters:

- press “reset all day counters” to select
- press **<** or **>** to scroll through the counters sub-menu

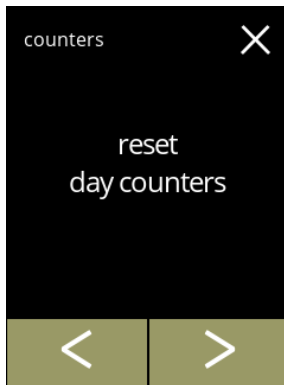

5.1.12c

Start reset:

- press **reset day counters** to confirm the reset off all day counters

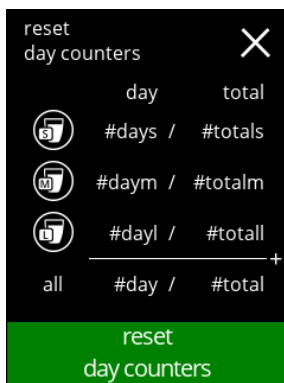

5.1.12d

Confirmation screen:

- press **✓** to confirm and continue the reset of all day counters
- press **✗** to cancel and go to the previous screen

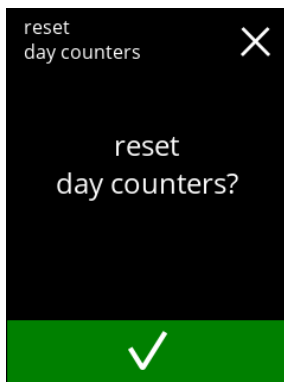

5.1.12e

Information screen

- screen 5.1.12c is displayed after a few seconds

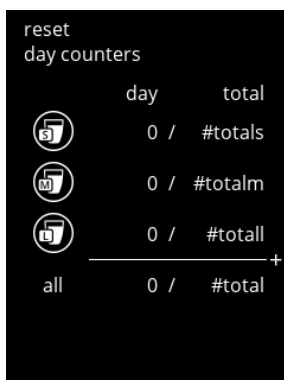

5.1.12f

5.1.12g

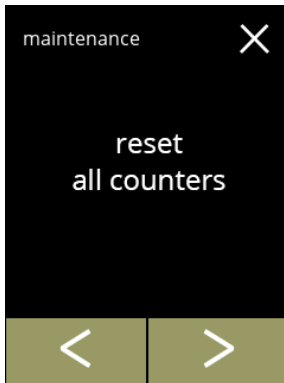

Total counters:

- press "total counters" to select
- press ◀ or ▶ to scroll through the counters sub-menu

5.1.12h

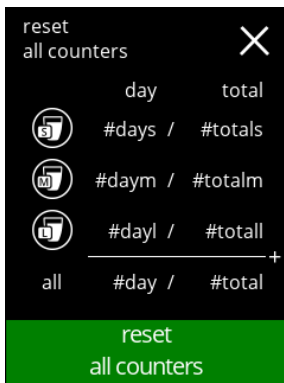

Start reset:

- press **reset all counters** to confirm the reset off all day counters

5.1.12i

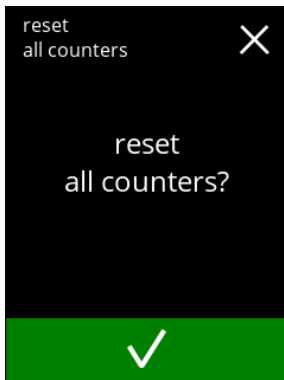

Confirmation screen:

- press  to confirm and continue the reset of all counters
- press  to cancel and go to the previous screen

5.1.12j

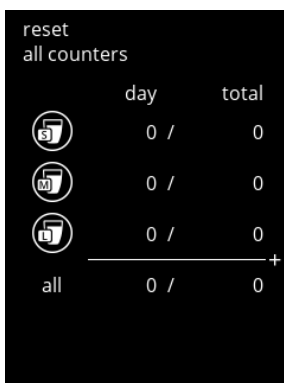

Information screen

- screen 5.1.12g is displayed after a few seconds

5.1.12k

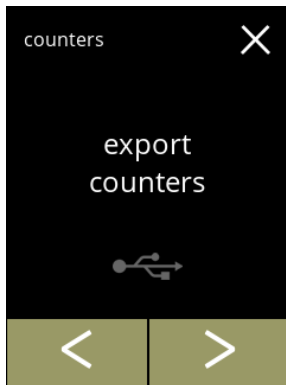

Export counters:

- place a USB stick
  - ▶ *If there is no USB stick in the machine this option is greyed out.*
- press "export counters" to confirm
- press ◀ or ▶ to scroll through the counters sub-menu

5.1.12l

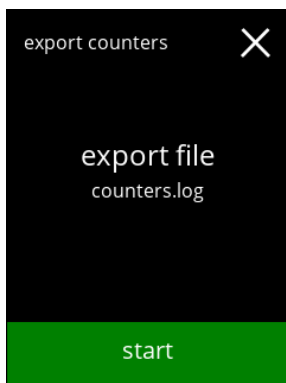

Start export counters:

- press **start** to begin the export

5.1.12m

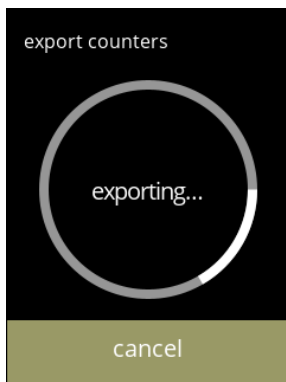

Progress screen

- wait until the process is finished
- press on **cancel** to interrupt

5.1.12n

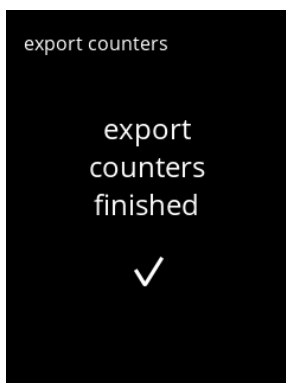

Information screens:

- screen 5.1.12k is displayed after a few seconds

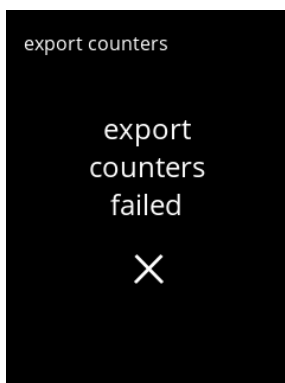

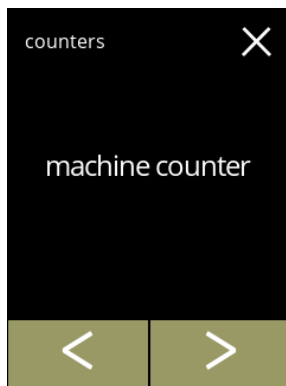

5.1.12o

Machine total counter:

- press "machine counter" to select
- press ◀ or ▶ to scroll through the counters sub-menu

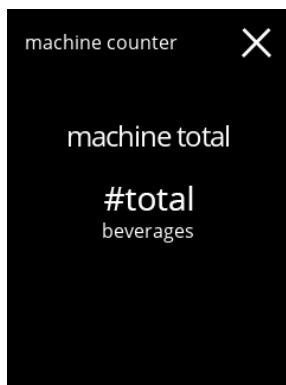

5.1.12p

Information screen:

- screen 5.1.12o is displayed after a few seconds

## 5.2 Beverages menu

The beverage menu contains all functions to adjust your beverages to your wishes. Select one of the available options

- press **◀** or **▶** to select the next option of the “beverage menu”
- press the “text area” to select the next level for that menu
- press **✕** to go back to chapter 5. Programming menu on p.13

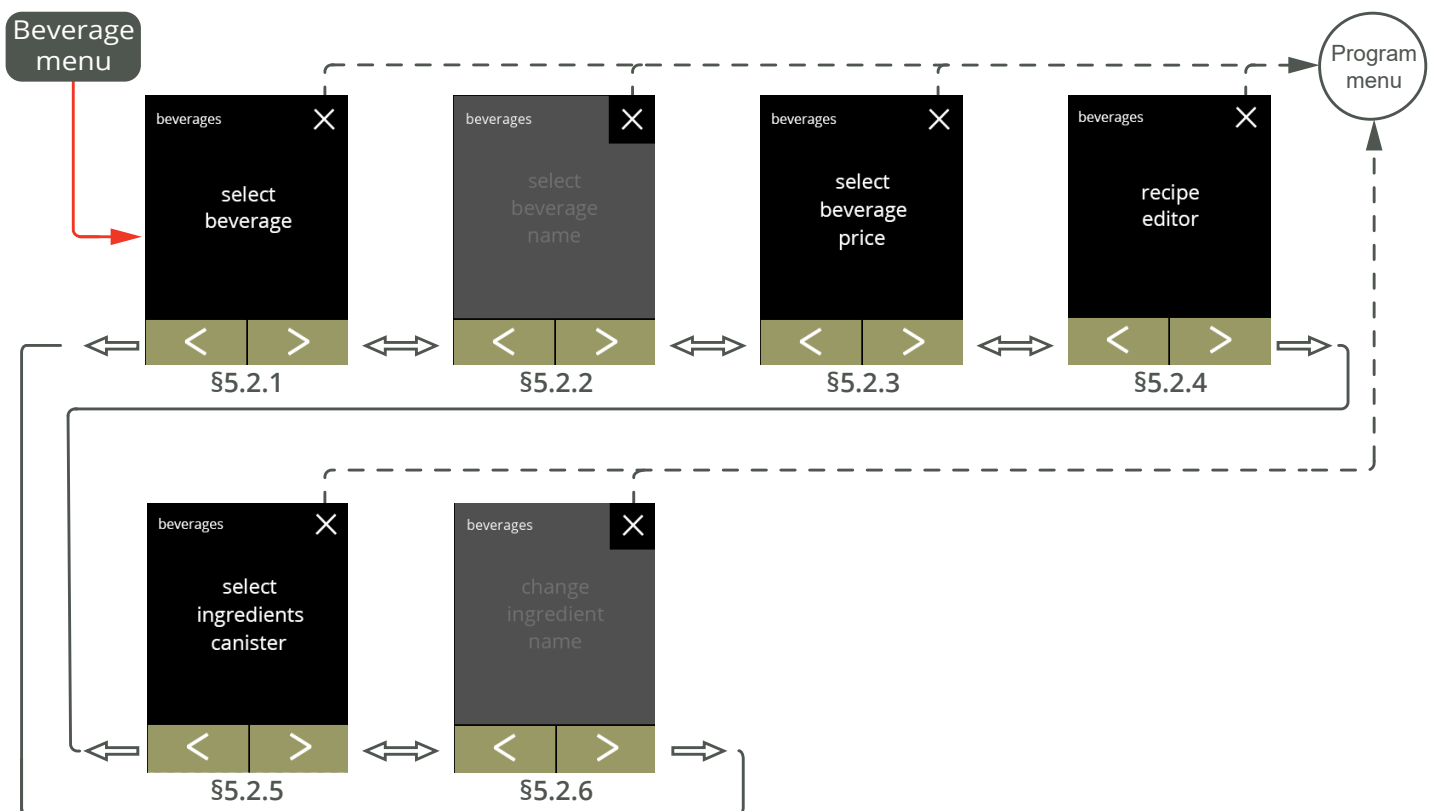



### 5.2.1 Add beverage to screen

In this menu the available beverages (recipes) can be selected and linked to a beverage position.

► *The beverage names used underneath are only meant as an example.*

5.2.1

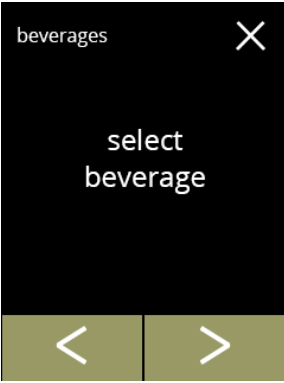

Place a beverage in the beverage selection screen:

- press "select beverage" to confirm
- press **<** or **>** to scroll through the beverage menu

5.2.1a



Available beverages in the beverage selection screen:

- press on a beverage to replace
- press **exit** to accept the current configuration and go to the previous screen

5.2.1b



Replace or delete a beverage on the screen

- *Delete is active as long as the beverage names are the same.*
- *Removing a beverage is not an option with the Bolero 11, as at least one drink must be available.*
- press **delete** to remove the beverage (three dots now replace the beverage) or
- press **<** or **>** to select another beverage
- press **save** to replace the beverage

Information screens:

- screen 5.2.1 is displayed after a few seconds

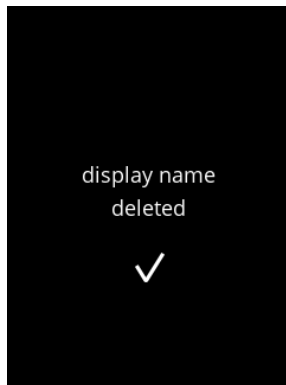

5.2.1c

## 5.2.2 Change beverage name

In this menu the name of the beverage can be changed to a own defined name.

► *This menu item is not yet available*

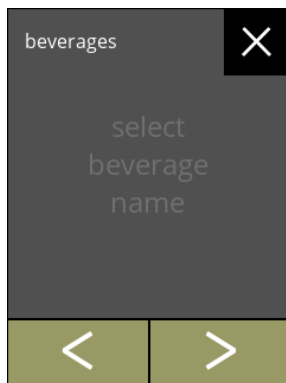

Change beverage name:

- press "*change beverage name*" to confirm
- press ◀ or ▶ to scroll through the beverage menu

5.2.2

### 5.2.3 Change beverage price

In this menu the price per beverage can be set or modified.  
 Prices can be a token or a currency.  
 Price can be set per cup type (cup, mug, decanter).

► *This menu item can be set, but is not effective because the payment software is not yet available §5.3.13 Connected devices on p.84.*

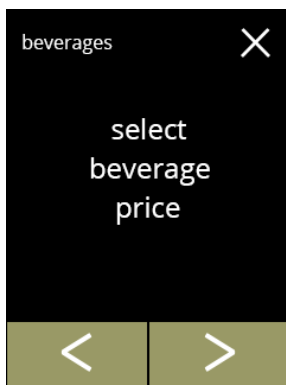

Change beverage price:

- press "change beverage price" to confirm
  - » Bolero 11: go to 5.2.3b
  - » Bolero 21: go to 5.2.3a
- press ◀ or ▶ to scroll through the beverage menu

5.2.3



Select a beverage:

- press on the beverage to change the prices
- press **exit** to accept the current beverage prices and go to the previous screen

5.2.3a

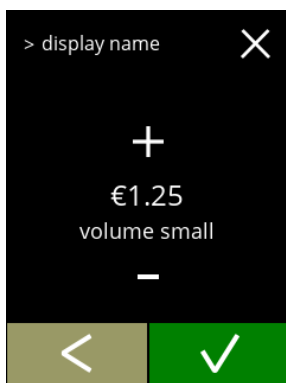

Adjust the 'volume small' price:

- press + or - to change beverage volume price
- press **✓** and go to the next screen

5.2.3b

5.2.3c

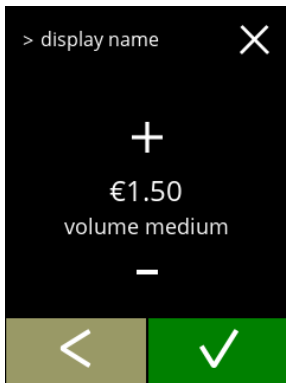

Adjust the 'volume medium' price:

- press **+** or **-** to change beverage volume price
- press **✓** and go to the next screen

5.2.3d

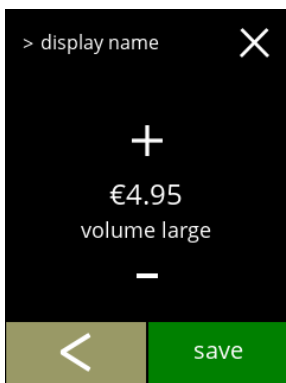

Adjust the 'volume large' price:

- press **+** or **-** to change beverage volume price
- press **save** to accept all and go to the next screen

5.2.3e

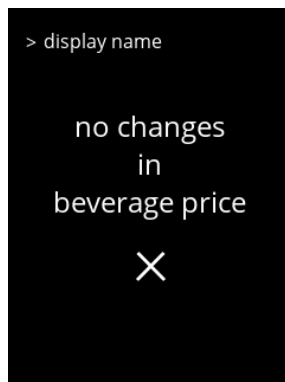
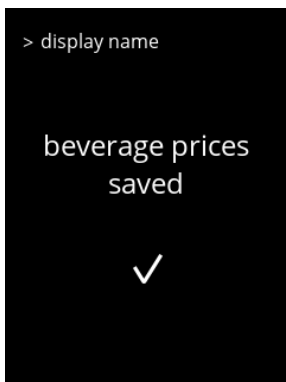

Information screens:

- screen 5.2.3a is displayed after a few seconds

5.2.3f

Example screen prices



Example screen tokens



## 5.2.4 Recipes

The following setting of the beverage recipes can be changed:

- volume
- strength
- mixer speed

▶ *The beverage and settings used in this section are only meant as an example.*

▶ *The default recipes (beverages) cannot be permanently removed.*

5.2.4

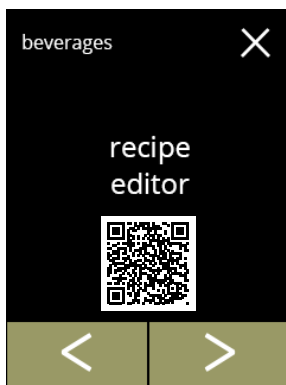

Change the recipe of a beverage:

- press "recipe editor" to confirm
- press ◀ or ▶ to scroll through the beverage menu

5.2.4a

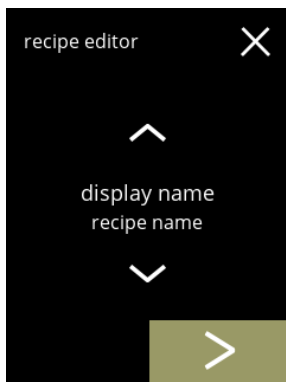

Recipe selection:

- press ▲ or ▼ to select a beverage
- press ▶ to confirm

▶ *The beverage and settings used are only meant as an example.*

5.2.4b

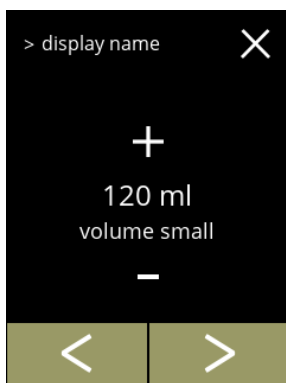

Volume (S):

- press ◀ or ▶ to select another volume
- press + or - to change the volume for the different cup sizes
- ▶ *Volume can be set from 0-30ml to 1000ml (recipe dependent)*
- press ✓ to confirm and go to the next screen

5.2.4c

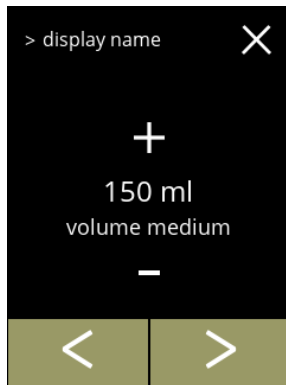

Volume (M):

- press or to select another volume
- press or to change the volume for the different cup sizes
  - ▶ *Volume can be set from 0-30ml to 1000ml (recipe dependent)*
- press to confirm and go to the next screen

5.2.4d

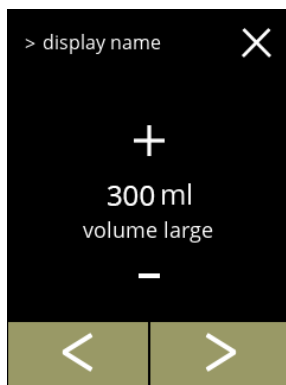

Volume (L):

- press or to select another volume
- press or to change the volume for the different cup sizes
  - ▶ *Volume can be set from 0-30ml to 1000ml (recipe dependent)*
- press to confirm
  - » go for a beverage with 1 ingredient to the next screen
  - » go for a beverage with 2 ingredients to screen 5.2.4h

5.2.4e

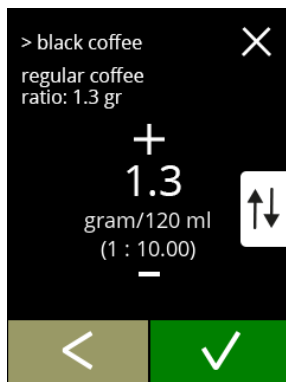

### One ingredient beverage

Strength:

- ▶ *Use the to switch between ratio and gr/ml*
- press or to change the ratio ingredient/water
- press to confirm

5.2.4f

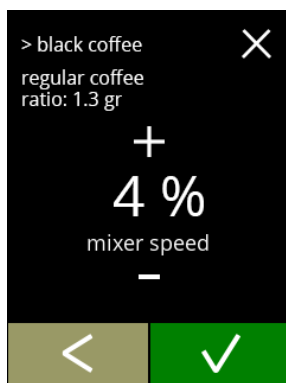

### One ingredient beverage

Mixer speed:

- press or to change mixer speed
- press to confirm

### One ingredient beverage

Information screen:

► A summary of the new ingredient settings is displayed.

- press **←** to go to the previous screen
- press **save** to confirm and go to 5.2.4m

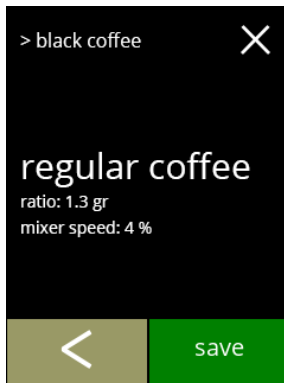

5.2.4g

### Two ingredients beverages

Strength, first ingredient:

► Use the **↑↓** to switch between ratio and gram/120 ml

- press **+** or **-** to change the ratio ingredient/water
- press **✓** to confirm

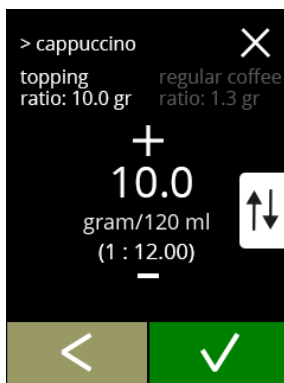

5.2.4h

### Two ingredients beverages

Mixer speed, first ingredient:

- press **+** or **-** to change the ratio ingredient/water
- press **✓** to confirm

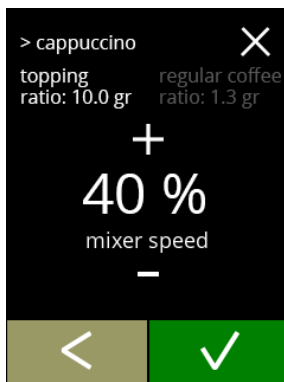

5.2.4i

### Two ingredients beverages

Strength, second ingredient:

► Use the **↑↓** to switch between ratio and gram/120 ml

- press **+** or **-** to change the ratio ingredient/water
- press **✓** to confirm

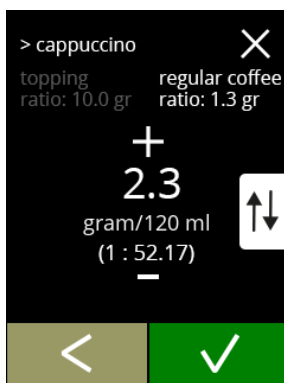

5.2.4j



**Two ingredients beverages**

Mixer speed, second ingredient:

- press **+** or **-** to change the ratio ingredient/water
- press **✓** to confirm

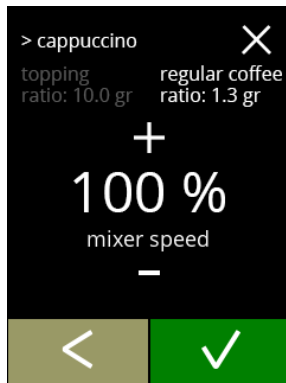

5.2.4k

**Two ingredients beverages**

Information screen:

► *A summary of the new ingredient settings is displayed.*

- press **←** to go to the previous screen
- press **save** to confirm and go to the next screen

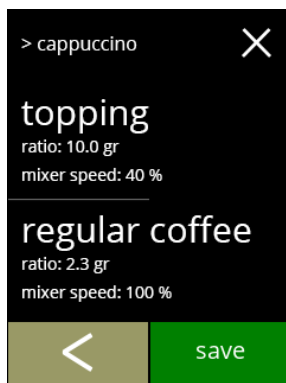

5.2.4l

Information screens:

- screen 5.2.4 is displayed after a few seconds

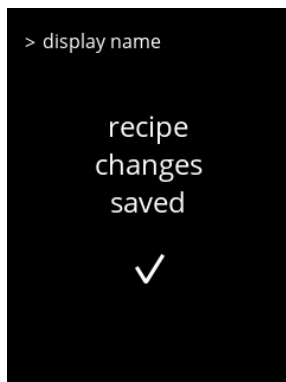

5.2.4m

Information screens:

- screen 5.2.4a is displayed after a few seconds



5.2.4n

## 5.2.5 Select ingredient canisters

Default *instant* ingredients will be available in the machine:

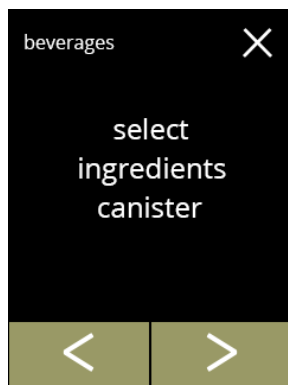

- regular coffee
- espresso coffee
- topping (only Bolero 21)
- cacao
- premix 1, 2, 3 and 4

Names of ingredients can be changed in §5.2.6 on p.64.



5.2.5

Select an ingredient per canister:

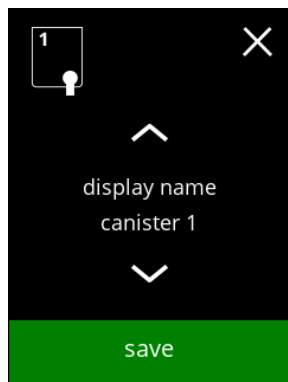

- press "select ingredient canister" to confirm
  - » Bolero 11 go to next screen
  - » Bolero 21 go to 5.2.5b
- press  or  to scroll through the beverage menu



5.2.5a

### Bolero 11

Select an ingredient



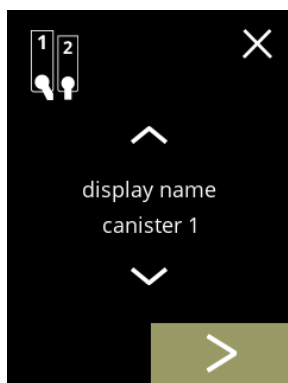

- press  or  to scroll through the available ingredients
- press  to confirm and go to the previous screen
  - ▶ *Save is only active if something has changed.*



5.2.5b

### Bolero 21 canister 1

Select a ingredient:



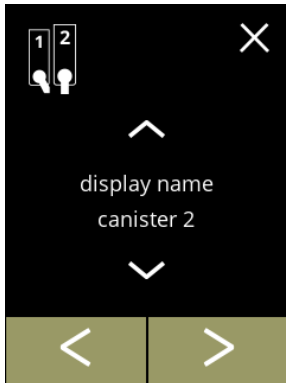

- press  to select the next canister
- press  or  to scroll through the available ingredients
- press on an ingredient to select and go to the next screen
  - ▶ *Confirm  is only active if something has changed.*



5.2.5c

**Bolero 21 canister 2**

Select a ingredient:

- press  to select the previous screen
  - press  to select the next screen
  - press  or  to scroll through the available ingredients
  - press on an ingredient to select and go to the next screen
- ▶ *Confirm  is only active if something has changed.*





5.2.5d

**Bolero 21**

Control screen:

▶ *This screen appears when  or  is pressed after the last canister.*

- press  to select the previous screen
- press  to confirm

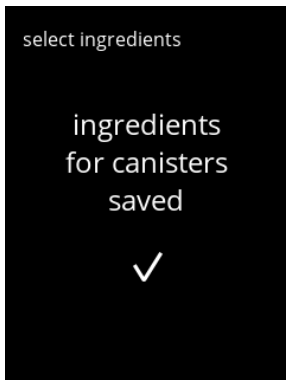

5.2.5e

Information screen:

▶ *Only if a new ingredient is different to the original one go to §5.2.1 Add beverage to screen on p.53. The beverages made with the previous ingredient are set to inactive and their names have been replaced by the 3 dots. That's why you have to combine new beverages with the buttons. When this action is completed, the machine will be operational again with the new ingredients.*

## 5.2.6 Change ingredient name

In this menu the name of the ingredient can be changed to an own defined ingredient name.

► *This menu item is not yet available*

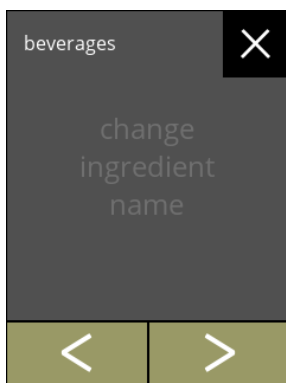

Change ingredient name:

- press "*change ingredient name*" to confirm
  - » Bolero 11 go to xxx
  - » Bolero 21 go to next screen
- press ◀ or ▶ to scroll through the beverage menu

5.2.6

### 5.3 Machine menu

You can programme the machine settings in the this menu.

Select one of the available options:

- press **⏪** or **⏩** to select the next option of the “machine menu”
- press the “text area” to select the next level for that menu
- press **⏴** to go back to chapter 5. Programming menu on p.13

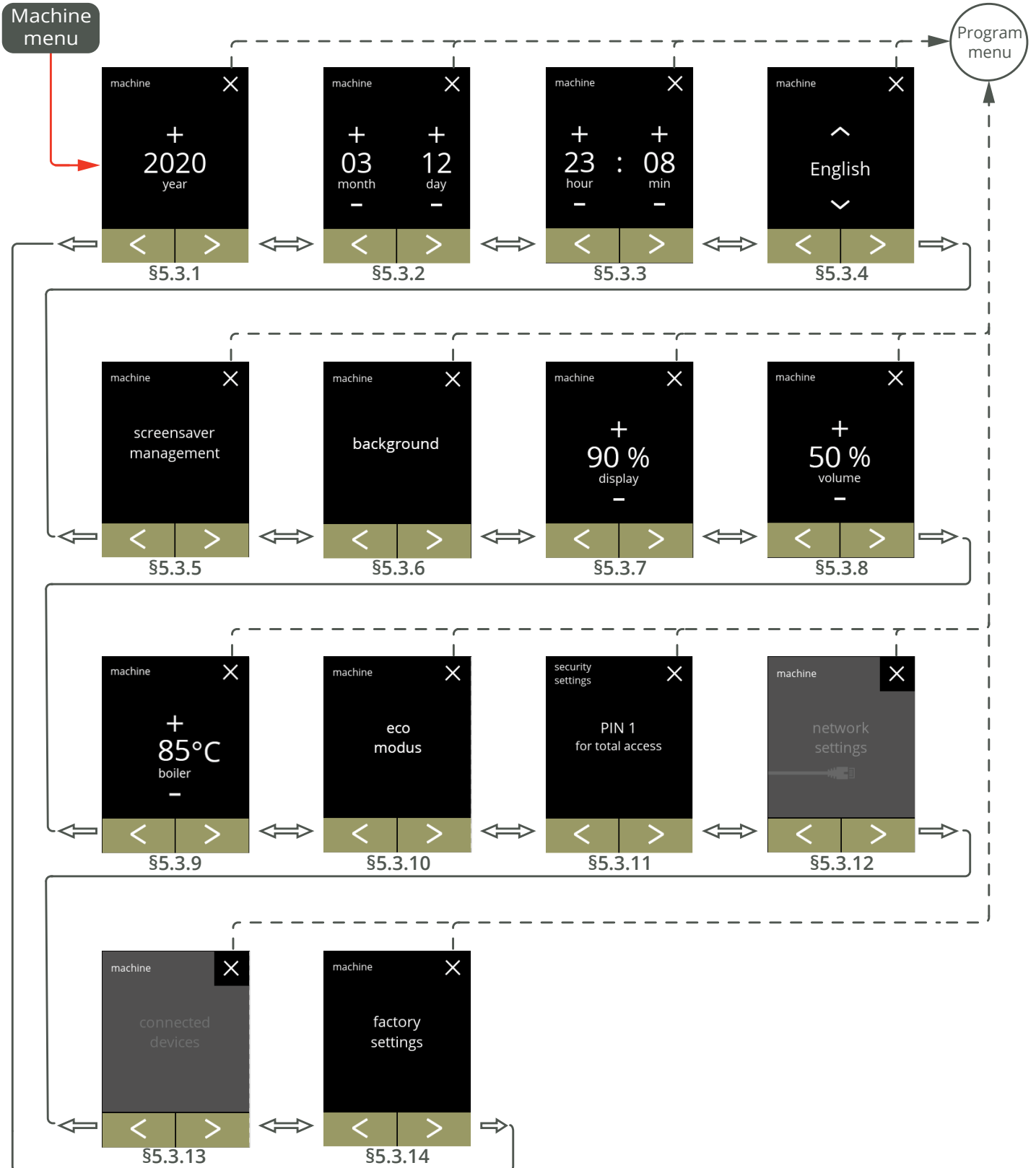

### 5.3.1 Year

Adjust the year.

5.3.1

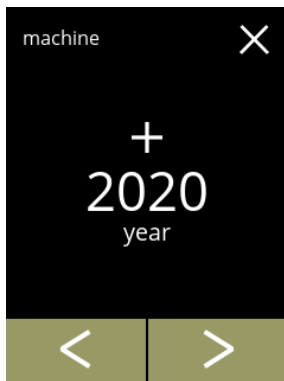

Change the date:

- press **+** or **-** to set the year
- press **<** or **>** to scroll through the machine menu

5.3.1a

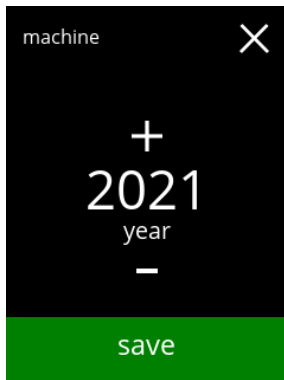

Confirming changes:

- press **save** to confirm
- ▶ *Save is only active if something has changed.*

### 5.3.2 Date

Adjust the day and month.

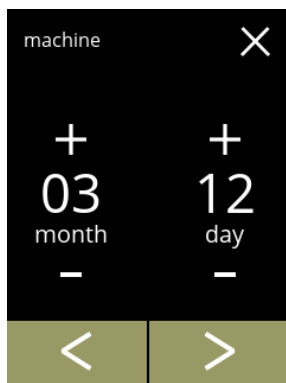

Change the month and day:

- press **+** or **-** to set the current the month and day
- press **◀** or **▶** to scroll through the machine menu

5.3.2

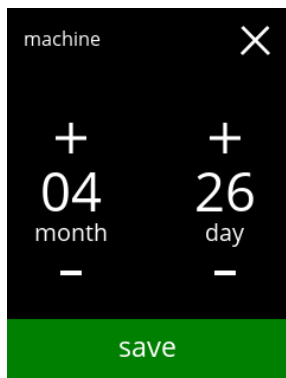

Confirming changes:

- press **save** to confirm
- ▶ *Save is only active if something has changed.*

### 5.3.3 Time

Adjust the time.

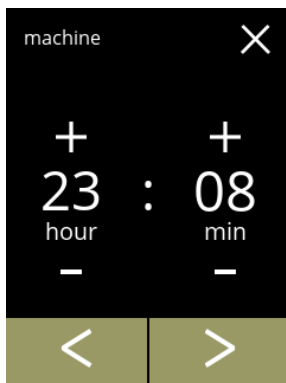

Change the time:

- press **+** or **-** to set the current the hour and minutes
- press **<** or **>** to scroll through the machine menu

5.3.3

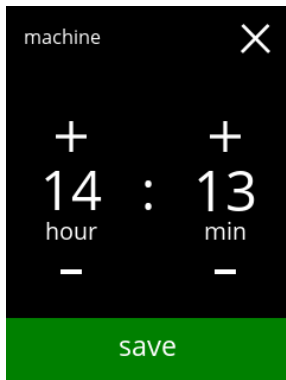

Confirming changes:

- press **save** to confirm
  - ▶ *Save is only active if something has changed.*



### 5.3.4 Language

The available languages are:



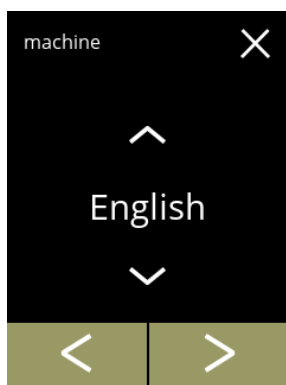

- English
- Spanish
- French
- Italian
- Dutch
- Norwegian
- Polish
- Portuguese
- Swedish
- Danish
- German

*Default: English*



5.3.4

Change the language:

- press  or  to scroll through the available languages
- press the language to set as the current language
- press  or  to scroll through the machine menu

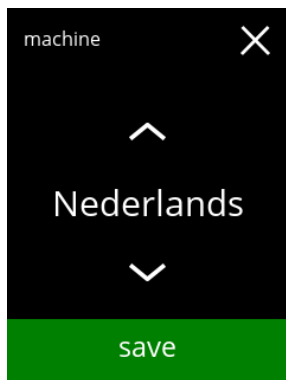

5.3.4a

Confirming of change:

- press  to confirm
- ▶ *Save is only active if something has changed.*

### 5.3.5 Screensaver management

In this menu, you can set when the screen saver becomes active.

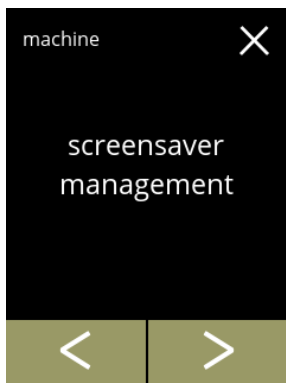

setting	screensaver
default	15 min.
minimum	1 min.
maximum	90 min.

The screensaver can be set to a own defined screensaver.  
You can always return to the default screensaver.



5.3.5

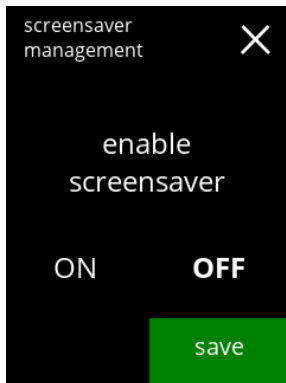

Change the screensaver:

- press "screensaver" to confirm
- press  or  to scroll through the machine menu



5.3.5a

Activate/deactivate the screensaver option:

- press "ON" or "OFF" to set the screensaver:
  - » select OFF and :
  - go to the next screen
  - » select ON and :
  - go to screen 5.3.5c
- ▶ *Save is only active if something has changed.*

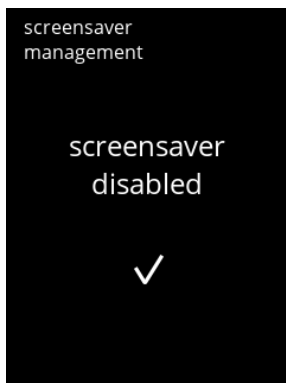

5.3.5b

Information screens:

- screen 5.3.5 is displayed after a few seconds

5.3.5c

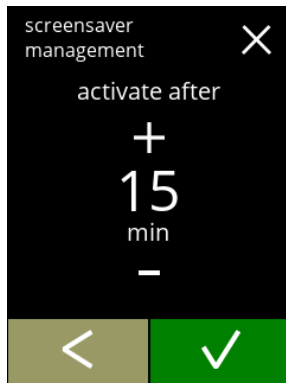

Set the time when the screensaver becomes active

- press **←** or **✓** to select the activation time
- press **✓** to confirm

5.3.5d

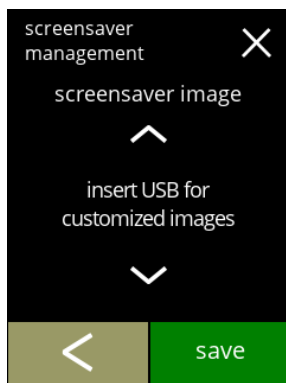

Change the screensaver image:

- press **→** to go to the next screen
- place a USB stick
  - ▶ *If there is no USB stick in the machine this option is greyed out.*
- press **←** or **✓** to select a custom image, see specifications below
- press **save** to go to the next screen

5.3.5e

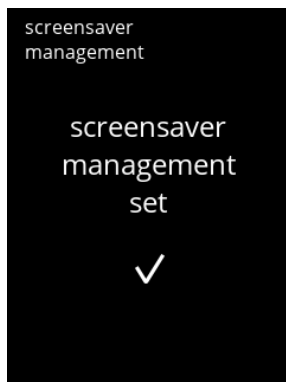

Information screens:

- screen 5.3.5 is displayed after a few seconds

### Specifications for customised screensaver:

- » size (wxh) : 240 x 320 pixels
- » resolution : 142 dpi
- » colour : RGB (8 bits)
- » save as so called 'baseline' JPG (not progressive)

▶ *The screensaver image does not need for a transparent background.*

### 5.3.6 Background

In this menu the background of the beverage selection screen can be set. The background can be set to a own defined background, see specifications. The default background remains available in the GUI, so you can always return to the default background.

#### Specifications for customised background:

- » size (wxh) : 240 x 320 pixels
- » resolution : 142 dpi
- » colour : RGB (8 bits)
- » save as so called 'baseline' JPG (not progressive)

► We recommend *not* use a light colour or white because of the readability.

5.3.6

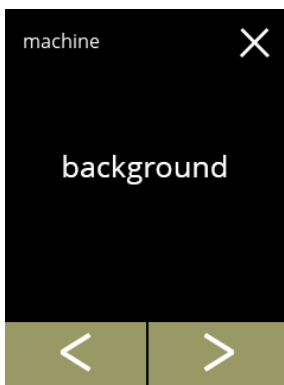

Change the background:

- press "background" to confirm
- press ◀ or ▶ to scroll through the machine menu

5.3.6a

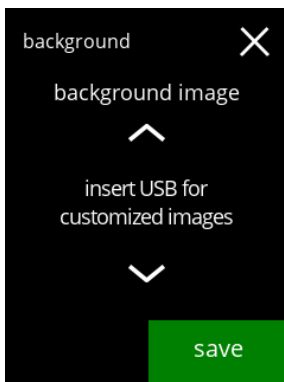

Change the background image:

- press ▶ to go to the next screen
- place a USB stick
  - *If there is no USB stick in the machine this option is greyed out.*
- press ⏪ or ⏩ to select a custom image
- press **save** to go to the next screen
  - *Save is only active if something has changed.*

5.3.6b

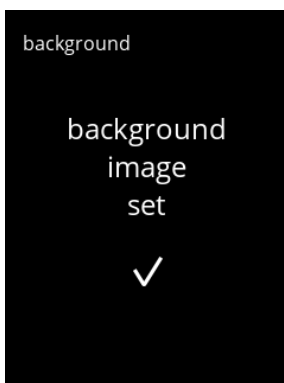

Information screen:

- screen 5.3.6 is displayed after a few seconds

### 5.3.7 Display brightness

The brightness of the display can be increased or decreased in steps of 5%.

setting	brightness
default	90%
minimum	20%
maximum	100%

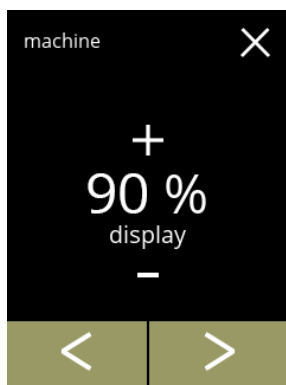

5.3.7

Change the display brightness:

- press **+** or **-** to select the brightness
- press **◀** or **▶** to scroll through the machine menu

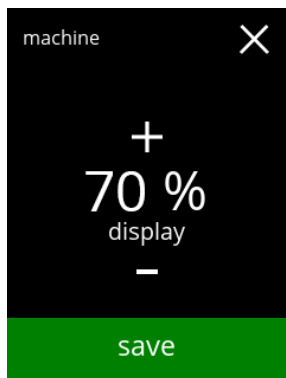

5.3.7a

Confirmation of change:

- press **save** to confirm
- ▶ *Save is only active if something has changed.*

### 5.3.8 Sound level feedback

The sound level of the feedback can be increased or decreased.

setting	sound level
default	50%
minimum	0% (OFF)
maximum	100%

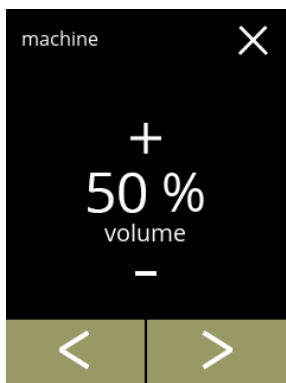

5.3.8

Sound level feedback:

- press **+** or **-** to set the sound level
  - ▶ *When the audio volume is increased or decreased, a beep is generated in that volume for verification.*
- press **←** or **→** to scroll through the machine menu

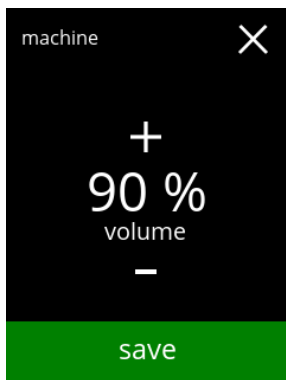

5.3.8a

Confirmation of change:

- press **save** to confirm
  - ▶ *Save is only active if something has changed.*

### 5.3.9 Boiler temperature

The temperature is set with an absolute temperature setting in degrees Celsius

setting	temperature
default	85°C
minimum	80°C
maximum	90°C

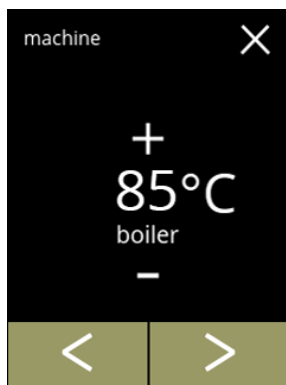

5.3.9

Change the boiler temperature:

- press **+** or **-** to set the temperature
- press **←** or **→** to scroll through the machine menu

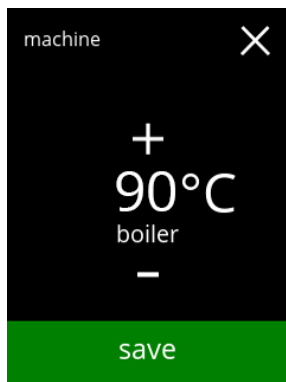

5.3.9a

Confirmation of change:

- press **save** to confirm
- ▶ *Save is only active if something has changed.*

### 5.3.10 Energy-saving mode (ECO)

After the set time, the Bolero will automatically go into sleep mode. The system becomes active when the screen is touched.

The time of the energy-saving mode can be set as defined in the table below.

1	2	3	4	5	6
Off	15 min.	30 min.	1 hour	2 hours	4 hours

**Default: 2 hours**

When energy-saving mode becomes active, the following actions are performed:

- boiler heating disabled
- backlight display set to low percentage.
- fan disabled

► *Energy control mode is dominant over screensaver mode*

5.3.10

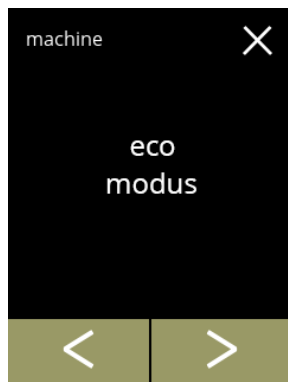

Change the energy-saving mode:

- press "eco modus" to confirm
- press ◀ or ▶ to scroll through the machine menu

5.3.10a

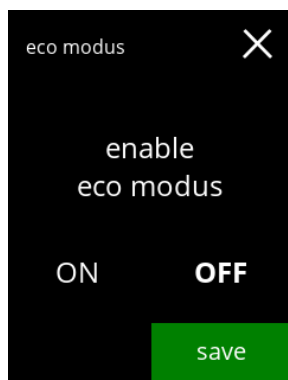

Activate/deactivate the energy-saving mode option:

- press "ON" or "OFF" to set energy-saving mode
  - » select OFF and **save** or ▶:
  - go to the next screen
  - » select ON and **save**:
  - go to screen 5.3.10c

► *Save is only active if something has changed.*



5.3.10b

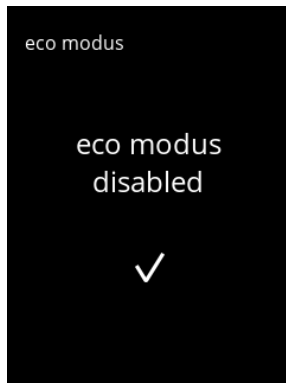

Information screens:

- screen 5.3.10 is displayed after a few seconds

5.3.10c

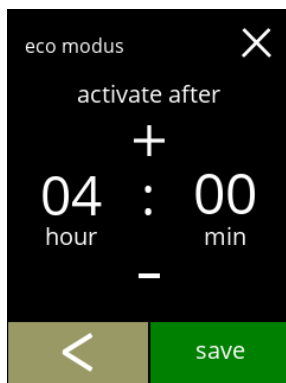

Set the time when the eco modus becomes active:

- press **+** or **-** to select the activation time
- press **save** to confirm and go to the next screen
- press **<** to go back to screen 5.3.10a

5.3.10d



Information screens:

- screen 5.3.10 is displayed after a few seconds

### 5.3.11 Security settings

In this menu the PIN code settings can be defined.

There are 2 PIN code:

- PIN 1 (general safeguard)
- PIN 2 (specific safeguard)

§7.2 on p.106 describes which PIN codes protect which options.

If a PIN code is entered to access the menu, it remains valid until the user leaves the menu again.

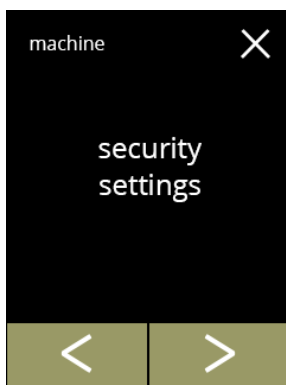

5.3.11

Change the security settings:

- press "security settings" to confirm
- press ◀ or ▶ to scroll through the machine menu
  - ▶ If a PIN code is active, it is indicated on this screen.

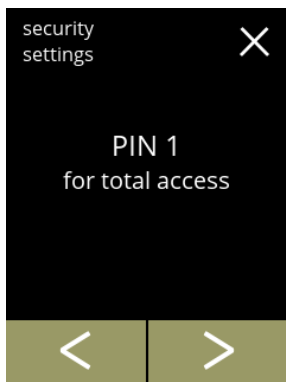

5.3.11a

Change the security settings:

- press "PIN 1 for total access":
  - » PIN 1 already set: go to screen 5.3.11f
  - » PIN 1 not yet set: go to the next screen
- press ◀ or ▶ to go to screen 5.3.11q for PIN 2

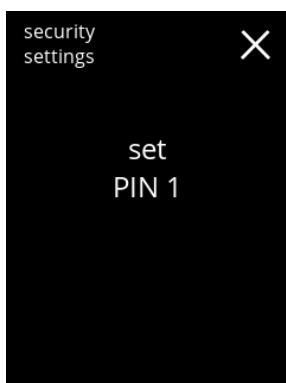

5.3.11b



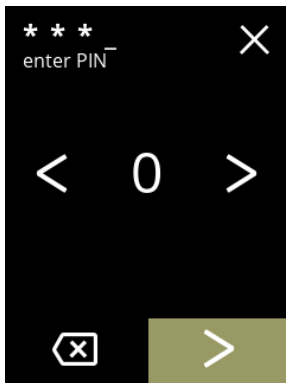

PIN code never entered:

- screen 5.3.11c is displayed after a few seconds

5.3.11c



Enter the PIN code:



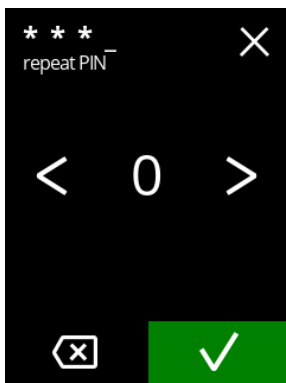

- press  or  to scroll through the numbers
- press on the number to select
- press  to delete a PIN number, see left corner
- press  when the 4 digit PIN code is entered

► When four numbers are entered the next screen is displayed to verify the PIN code.

5.3.11d



Verify the PIN code:

- press  or  to scroll through the numbers
- press on the number to select
- press  to delete a PIN number, see left corner
- press  to verify the PIN code entered and go to the next screen

► When the PIN code does **not** match, you will receive another attempt to enter the correct code.

5.3.11e

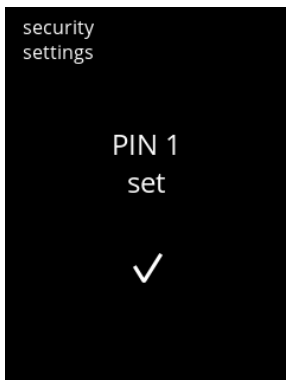



Information screen:

- screen 5.3.11a is displayed after a few seconds

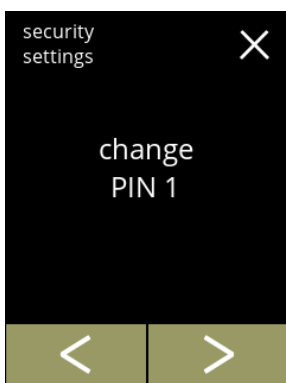
5.3.11f



Change PIN 1:

- press "change PIN 1" to confirm and go to the next screen
- press  or  to go to screen 5.3.11m

5.3.11g

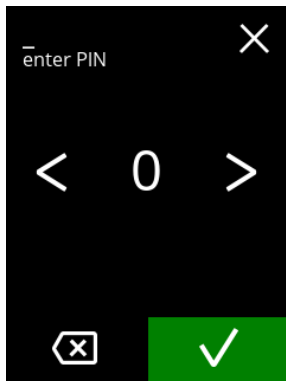

Enter the PIN code:

- press ◀ or ▶ to scroll through the numbers
- press on the number to select
- press ☒ to delete a PIN number, see left corner
- press ✓ to verify the PIN code entered and go to the next screen

▶ *When the PIN code does **not** match, you will receive another attempt to enter the correct code.*

5.3.11h

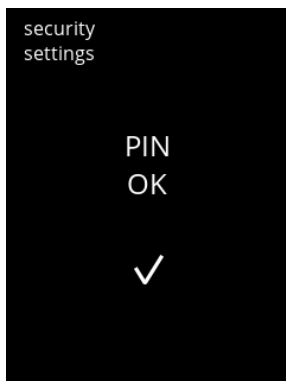

Information screen:

- the next screen is displayed after a few seconds

5.3.11i

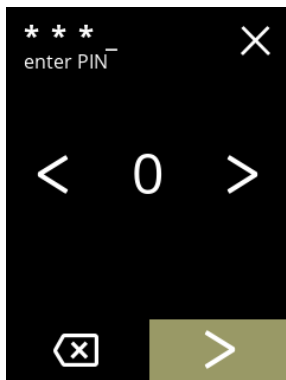

Enter the new PIN code:

- press ◀ or ▶ to scroll through the numbers
- press on the number to select
- press ☒ to delete a PIN number, see left corner
- press ▶ when the 4 digit PIN code is entered

▶ *When four numbers are entered the next screen is displayed to verify the PIN code.*

5.3.11j

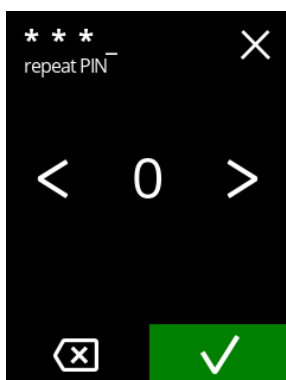

Verify the new PIN code:

- press ◀ or ▶ to scroll through the numbers
- press on the number to select
- press ☒ to delete a PIN number, see left corner
- press ✓ to verify the PIN code entered and go to the next screen

▶ *When the PIN code does **not** match, you will receive another attempt to enter the correct code.*

5.3.11k





Information screen:

- screen 5.3.11a is displayed after a few seconds

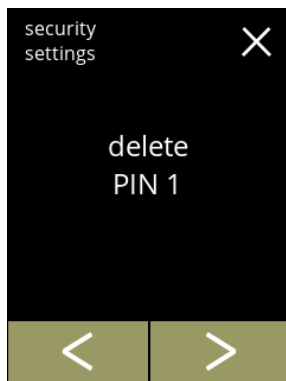
5.3.11l





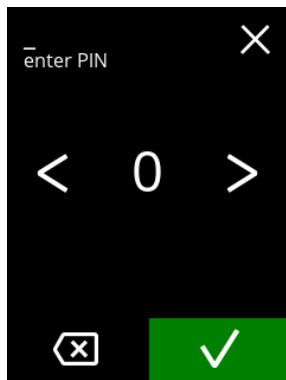

Delete PIN 1:

- press "delete PIN 1" to confirm and go to the next screen
- press  or  to go to screen 5.3.11f

5.3.11m



Enter the PIN code:

- press  or  to scroll through the numbers
- press on the number to select
- press  to delete a PIN number, see left corner
- press  to verify the PIN code entered and go to the next screen

► When the PIN code does **not** match, you will receive another attempt to enter the correct code.

5.3.11n

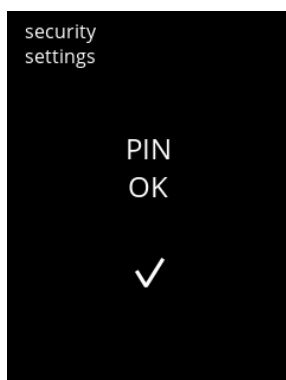



Information screen:

- the next screen is displayed after a few seconds

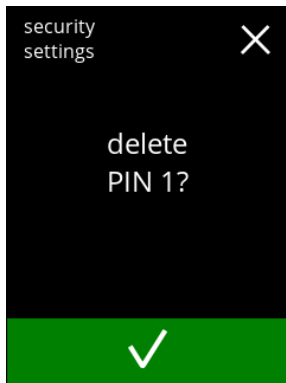
5.3.11o



Confirmation screen:

- press  to cancel
- press  to confirm and go to the next screen

5.3.11p

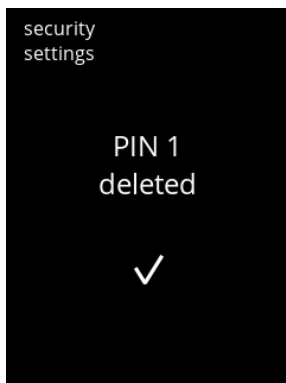



Information screen:

- screen 5.3.11a is displayed after seconds

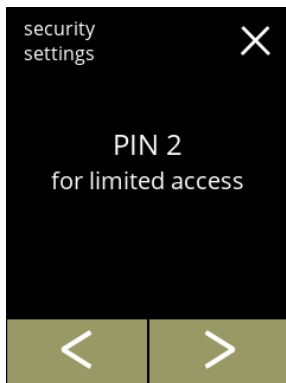
5.3.11q



Change the security settings:

- press "PIN 2 for limited access" to select:
  - ▶ *the screens that follow are the same as PIN 1 (only PIN 1 is replaced by PIN 2 in the screens 5.3.11b to 5.3.11p)*
- press  or  to go to screen 5.3.11a for PIN 1

### 5.3.12 Network settings

In this menu the Ethernet as well as Wi-Fi (if applicable) settings can be set and modified. This setting can be set or modified with user level 3 or higher.

A DHCP server (=Dynamic Host Configuration Protocol) checks which IP addresses are available when a device is trying to connect to a network. The first available IP address (at that moment) is assigned to this device.

#### **Ethernet settings**

DHCP can be set to ON or OFF.

When DHCP is ON subjects mentioned below are assigned automatically. They are visible but not editable.

When DHCP is OFF (meaning a static IP-address needs to be selected) then subjects underneath should be filled in.

IP address (format: 000.000.000.000)

Net mask (format: 000.000.000.000)

DNS (format: 000.000.000.000)

Gateway (format: 000.000.000.000)

#### **Wi-Fi**

SSID (=Service Set Identifier). SSID gives names to wireless networks. This makes it possible to select a Wi-Fi-network from a list. The names will be shown and click to connect. Mostly a password needs to be entered to connect with the network. After the machine is connected to a Wi-Fi-network, the procedure is the same as with the Ethernet settings mentioned above.

► *This menu item is not yet available*

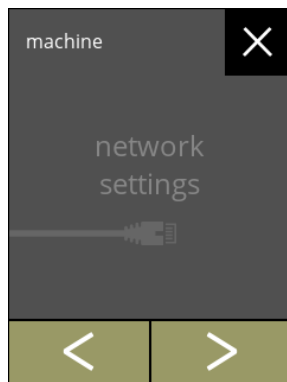

Change the network settings:

- press "network settings" to confirm
  - press ◀ or ▶ to scroll through the machine menu
- *If the machine is not connected the connector is greyed out.*

5.3.12

### 5.3.13 Connected devices

In this menu settings of external devices connected to the machine can be set or modified. In case of a connected payment module, the possibility to cancel a beverage can be disabled. Up to 3 payment devices can be connected.

► *This menu item is not yet available*

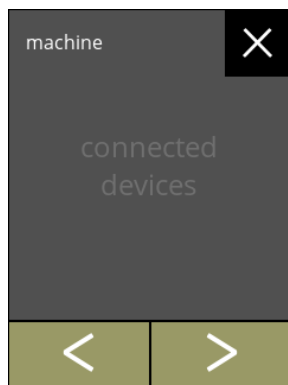

Change the connected devices:

- press "connected devices" to confirm
- press ◀ or ▶ to scroll through the machine menu
- *If no external payment system is connected to the machine, the text on this screen will remain greyed out.*

5.3.13



### 5.3.14 Reset to factory settings

A factory reset reverts the machine to how it was manufactured.



Exceptions are:

- firmware
- machine counter (only the day and beverage counters are reset)
- descale counter
- water filter
- firmware history

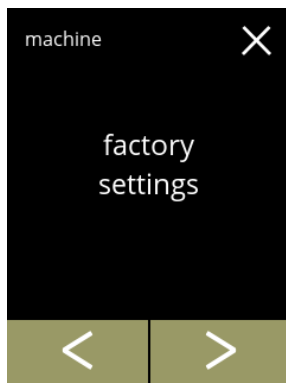
5.3.14



Reset to factory settings:

- press "factory settings" to confirm
- press  or  to scroll through the machine menu

5.3.14a

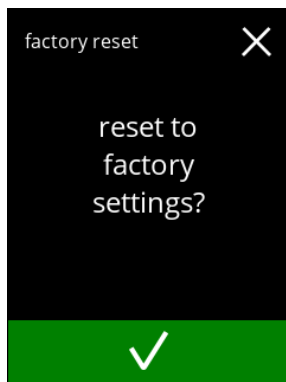

Confirmation screen:

- ▶ *First save the customized data, see §5.4.5 Export machine settings on p.93.*
- press  to confirm

5.3.14b



Information screen:

- the next screen is displayed after a few seconds

Information screen:

- the machine starts automatically (this takes a while)

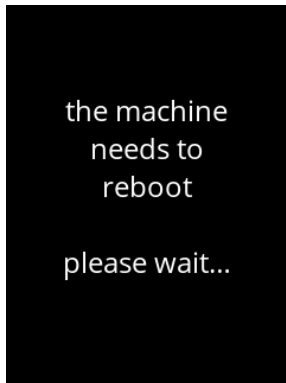

5.3.14c

## 5.4 Software menu

All firmware related items can be read, set or changed in the software menu. Select one of the available options:

- press **↵** or **⏪** to select the next option of the “software menu”
- press the “text area” to select the next level for that menu
- press **⏩** to go back to chapter 5. Programming menu on p.13

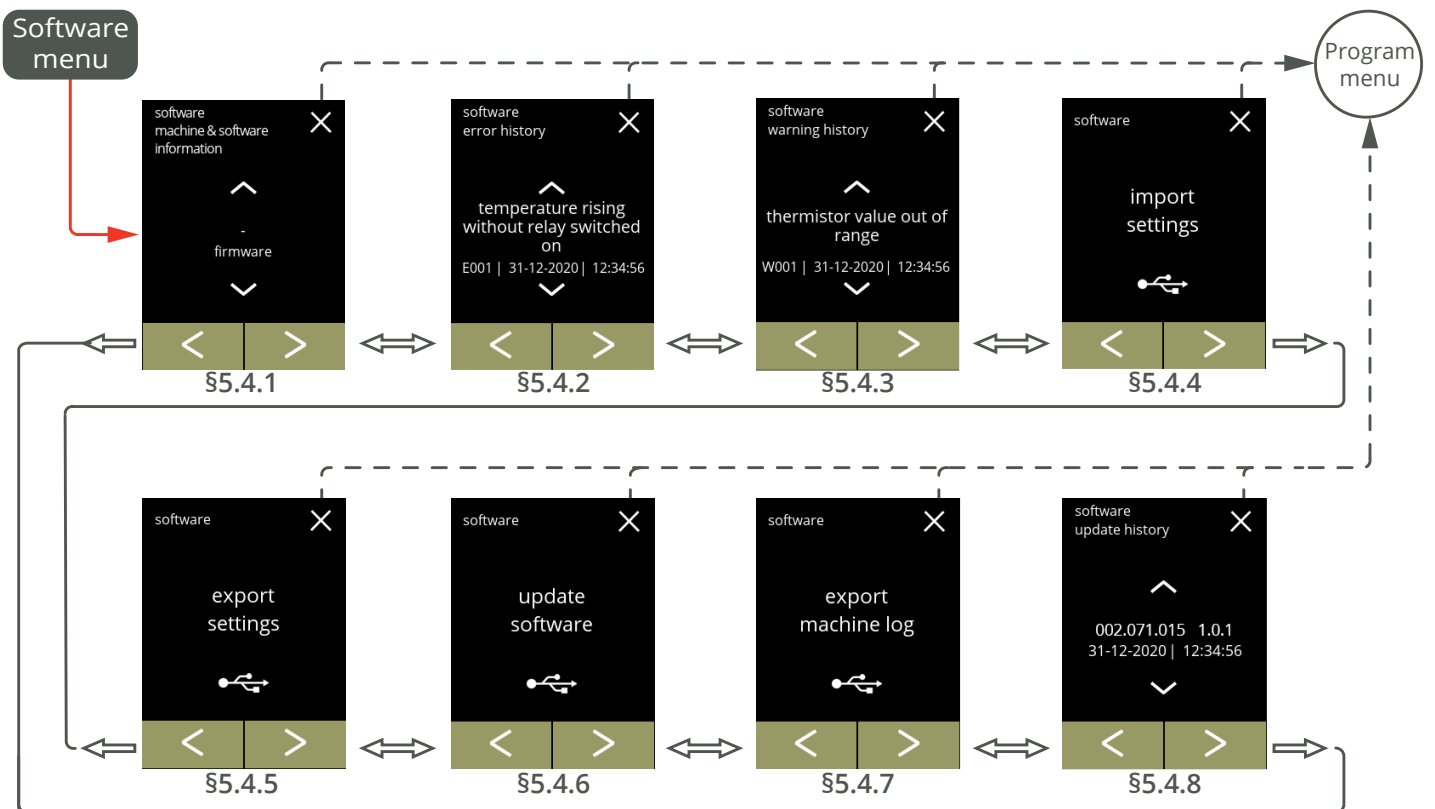

### 5.4.1 Machine and software information



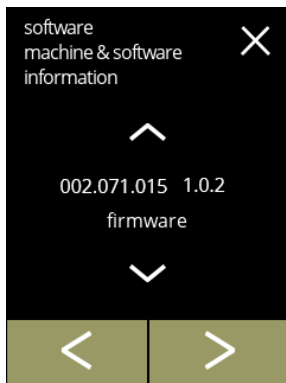

This menu shows information that identifies the machine (article and version number). You can find the following items/version:

- firmware
- application (I/O)
- bootloader (I/O)
- touchscreen controller
- application (HMI)
- bootloader (HMI)



5.4.1

Information screens:

- press  or  to retrieve the other machine & software information
- press  or  to scroll through the software menu

## 5.4.2 Error log

In this menu the error history is shown.

The following items are displayed:



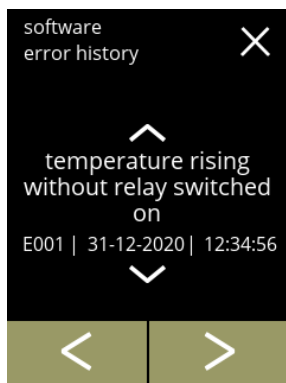

- error code
- error message
- date and time

The error log can contain up to 50 errors, the last error code generated is displayed first.

► *An overview of the errors can be found in §6.2 on p.103.*



Information screens:

- press  or  to retrieve the error history
- press  or  to scroll through the software menu

► *The last error code generated is shown first.*

5.4.2

### 5.4.3 Warning log

In this menu the warning history is shown.

The following items are displayed:



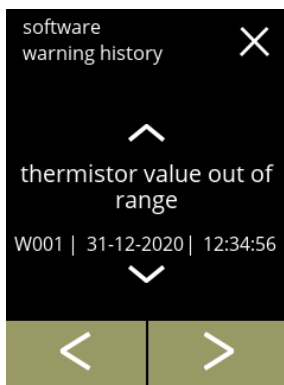

- warning code
- warning message
- date and time

The warning log can contain up to 50 errors, the last error code generated is displayed first.

► *An overview of the warnings can be found in §6.1 on p.101.*



Information screens:

- press  or  to retrieve the warning history
- press  or  to scroll through the software menu

► *The last warning code generated is shown first.*

5.4.3

### 5.4.4 Import machine settings

In this menu the settings of another machine (or from the Bravilor factory) can be imported. With settings the following is meant:

- recipes
- machine configuration
- security levels

► *Only if the identities of both machines are the same can the settings be transferred.*

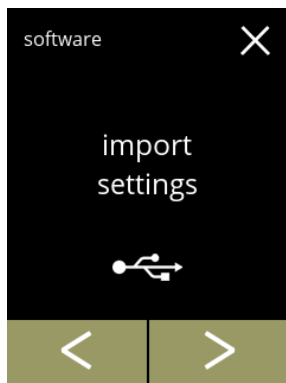

5.4.4

Import machine settings:

- place a USB stick
  - *If there is no USB stick in the machine this option is greyed out.*
- press "import settings" to confirm
- press **◀** or **▶** to scroll through the software menu

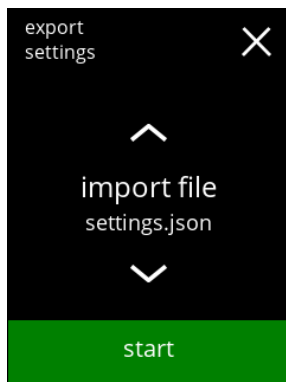

5.4.4a

Import the settings on the machine:

- press **▲** or **▼** to select a setting file
- press **start** to begin the import

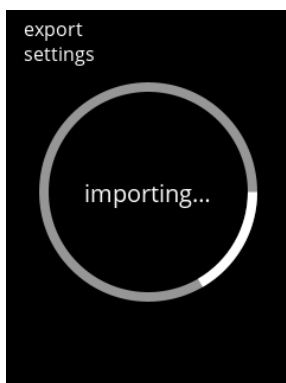

5.4.4b

Progress screen

- wait until the process is finished

5.4.4c

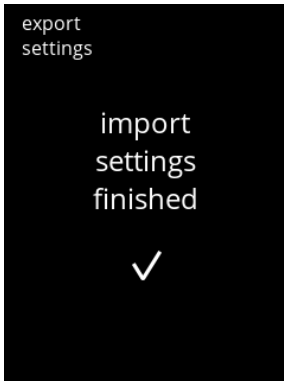

Information screen:  
• the next screen displayed after a few seconds

5.4.4d

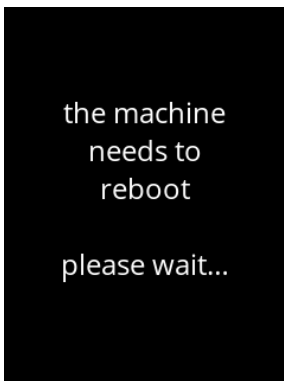

Information screen:  
• the machine starts automatically (this takes a while)

5.4.4e

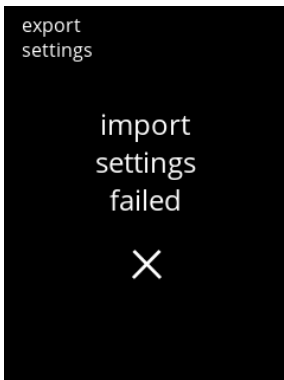

information screen:  
• screen 5.4.4 is displayed after a few seconds



### 5.4.5 Export machine settings

In this menu the machine settings are exported to a file.  
With settings the following is meant:

- recipes
- machine configuration
- security levels
- identity (used to check if the new machine has the same identity)

► *Keep in mind that the security levels of the machine are also copied.*

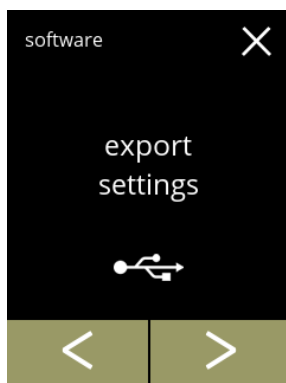

5.4.5

Export machine settings:

- place a USB stick
  - *If there is no USB stick in the machine the export button is greyed out.*
- press "export settings" to confirm
- press **◀** or **▶** to scroll through the software menu

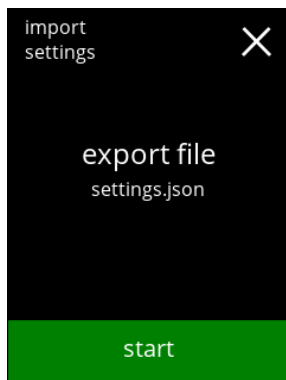

5.4.5a

Export the settings of the current machine:

- press **start** to begin the export

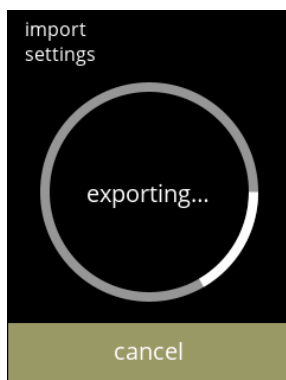

5.4.5b

Progress screen

- wait for the process to finish
- press on **cancel** to interrupt

Information screens:

- screen 5.4.5 is displayed after a few seconds

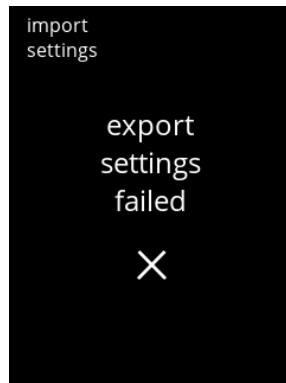
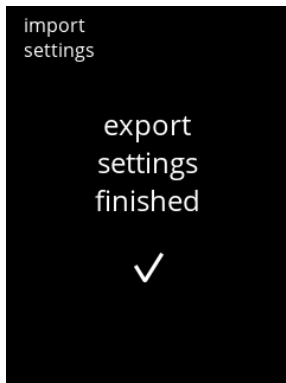

5.4.5c

## 5.4.6 Update software

In this menu the software can be updated.

The software (package) can be selected from the USB stick and after selection the package information will be shown.

► *The software can only be updated, a downgrade is not possible.*

5.4.6

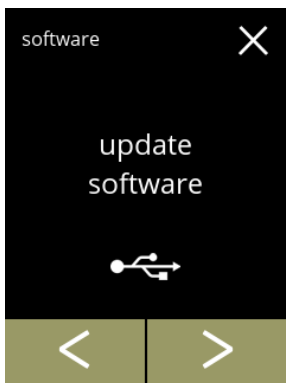

Update the machine software:

- place a USB stick
  - *If there is no USB stick in the machine this option is greyed out.*
- press "update software" to confirm
- press  or  to scroll through the software menu

5.4.6a

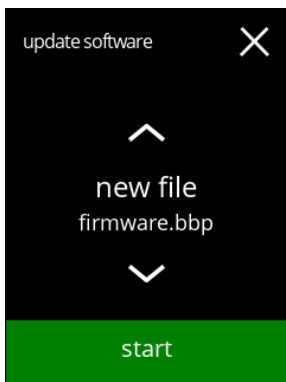

Select the file to update the software:

- press  or  to select a file
- press  to begin the update

5.4.6b

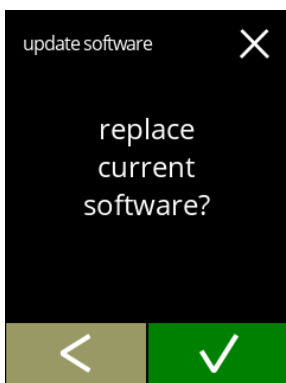

Confirmation screen:

- *Be aware that your current firmware will be overwritten.*
- press  to confirm
- press  to go to the previous screen

5.4.6c

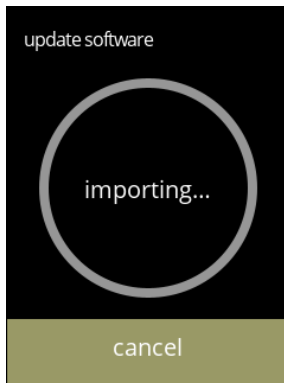

Progress screen

- wait until the process is finished
- press on **cancel** to interrupt

► *If the file cannot be imported (earlier version or wrong format) the screen is aborted and screen 5.4.6f appears.*

5.4.6d

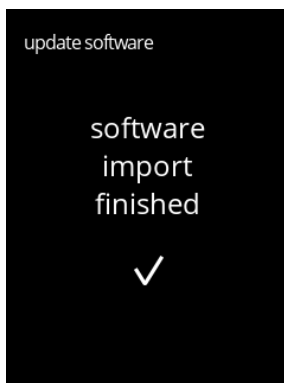

Information screen:

- the next screen is displayed after a few seconds

5.4.6e

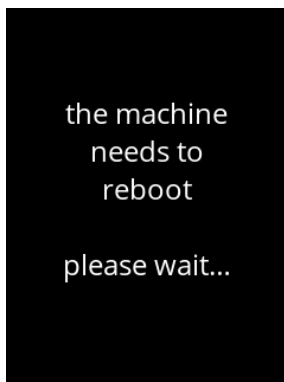

Information screen:

- the machine starts automatically (this takes a while)
- the next screen is displayed automatically

5.4.6f

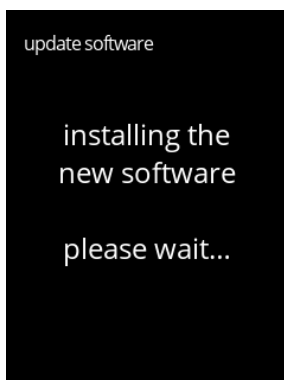

Information screen:

- the beverage selection screen is displayed when the software is installed

### 5.4.7 Export machine log

In this menu the machine log is exported to a file.

The report consists of dispense counters (free and paid), warning and error messages.

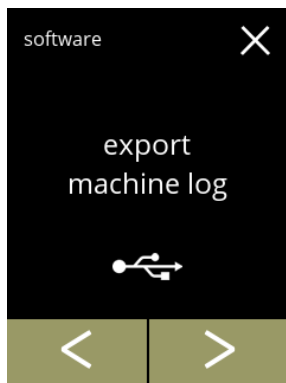

5.4.7

Export machine log:

- place a USB stick
  - ▶ *If there is no USB stick in the machine this option is greyed out.*
- press "export machine log" to confirm
- press **<** or **>** to scroll through the software menu

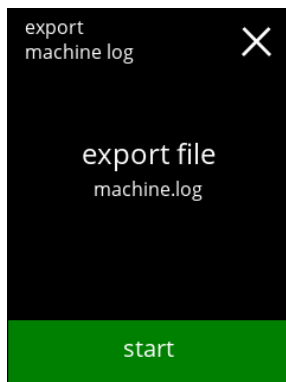

5.4.7a

Export the log file of the machine:

- press **start** to begin the export

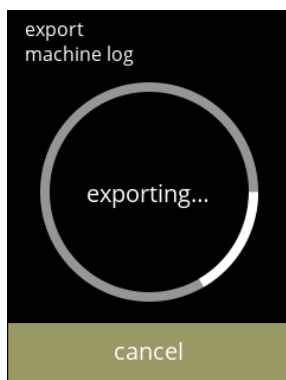

5.4.7b

Progress screen

- wait until the process is finished
- press on **cancel** to interrupt

Information screens:

- screen 5.4.7 is displayed after a few seconds

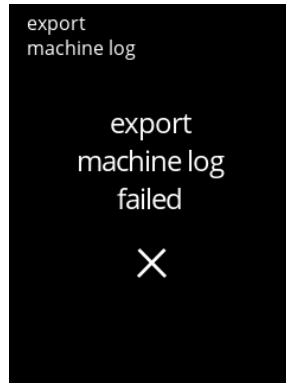
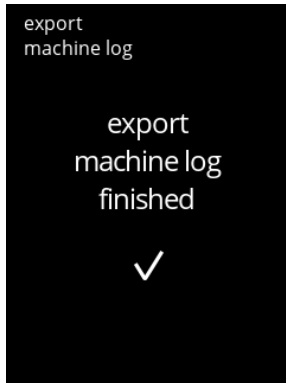

5.4.7c

### 5.4.8 Update history

In this menu software history is shown.



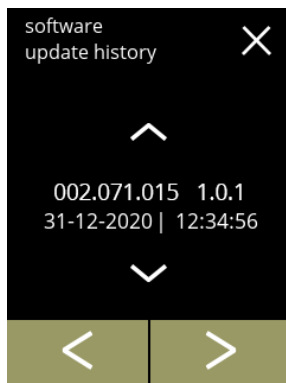

The following software history are shown with item number, version, date and time:

- product software (HMI)
- I/O board software
- touch software
- Wi-Fi/Bluetooth
- bus devices (if they are connected)

The update log can contain up to 50 items, the last update is shown first.



Information screens:

- press  or  to retrieve the update history
- press  or  to scroll through the software menu

5.4.8

## 5.5 Online info

Online information can be approached via the QR code shown on the screen.  
Select one of the available options

- press ◀ or ▶ to select the next option of the “machine menu”
- press the “text area” to select the next level for that menu
- press ✕ to go back to chapter 5. Programming menu on p.13

5.5.1

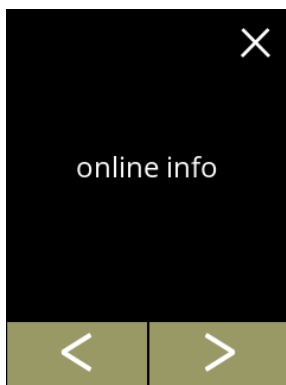

Online information:

- press “online info” to confirm
- press ◀ or ▶ to scroll through the machine menu

5.5.1a

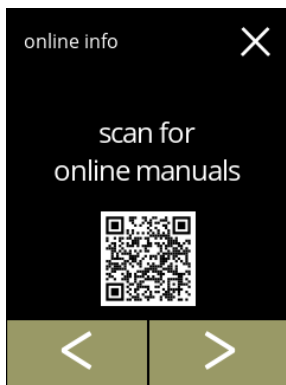

Online manuals:

- press ◀ or ▶ to scroll through the available QR codes
- scan the QR code to get the latest online manual(s)

5.5.1b

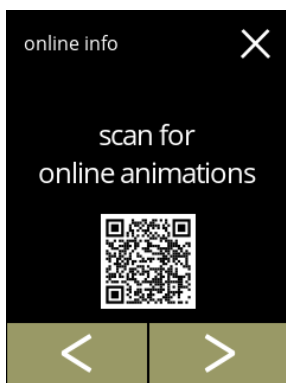

Online animations:

- press ◀ or ▶ to scroll through the available QR codes
- scan the QR code to get the latest online animation(s)



## 6. Messages and errors

### 6.1 Warning messages

Warnings are used to inform you of a state which can prevent the Bolero from working correctly. In general warnings are shown after selecting a beverage.

- ▶ *The messages/warnings are displayed for 30 seconds then return to the home screen.*
  - » a message (Mxxx) is a positive confirmation of a user action.
  - » a warning (Wxxx) indicates a problem or potentially harmful condition



Example display for a warning.

These notifications are stored in a log file (§5.4.3 on p.90).

6.1a

code	description	action
W001	temperature sensor out of range	<ul style="list-style-type: none"> <li>• no action required, disappears after a few seconds, becomes after 3 incidents E002</li> </ul>
W002	temperature too high	<ul style="list-style-type: none"> <li>• no action required, disappears after a few seconds</li> </ul>
W003	temperature not rising while relay engaged	<ul style="list-style-type: none"> <li>• no action required, disappears after a few seconds, becomes E004 after 3 incidents within certain time</li> </ul>
W004	canister motor not detected	<ul style="list-style-type: none"> <li>• reset the message on the screen</li> <li>» if the warning persists, contact your dealer</li> </ul>
W005	<i>not used</i>	
W006	mixing systems must be rinsed	<ul style="list-style-type: none"> <li>• reset the message on the screen</li> <li>» rinse the mixing system, see §5.1.1 on p.15.</li> </ul>
W007	machine must be descaled soon	<ul style="list-style-type: none"> <li>• reset the message on the screen</li> <li>» schedule the descaling procedure soon</li> </ul>
W008	machine must be descaled now	<ul style="list-style-type: none"> <li>• reset the message on the screen (the warning will pop-up after every dispensed beverage)</li> <li>» descale the machine, see §5.1.2 on p.17)</li> </ul>

code	description	action
W009	water filter must be changed soon	• reset the message on the screen
		» schedule water filter replacement soon
W010	water filter must be changed now	• reset the message on the screen (the warning will pop-up after every dispensed beverage)
		» replace the water filter and confirm in §5.1.3 Water filter management on p.24
M011	payment device connection successful	• no action required, disappears after a few seconds
W012	payment device connection failed	• no action required, disappears after a few seconds
		» check the connections and restart the payment device
		» if the error persists, contact your dealer
M013	Ethernet connection successful	• no action required, disappears after a few seconds
W014	Ethernet device connection failed	• no direct action required, disappears after a few seconds
		» check the connections and/or settings (§5.3.12 on p.83) and restart the machine
M015	Wi-Fi connection successful	• no action required, disappears after a few seconds
W016	Wi-Fi connection failed	• no direct action required, disappears after a few seconds
		» check the connections and/or settings (§5.3.12 on p.83) and restart the machine
M017	Bluetooth connection successful	• no action required, disappears after a few seconds
W018	Bluetooth device connection failed	• no direct action required, disappears after a few seconds
		» check the connections and/or settings (§5.3.12 on p.83) and restart the machine
W019	<i>not used</i>	
W020	contact your dealer for preventive maintenance	• reset the message on the screen, the message will recur several times after which it becomes E026

## 6.2 Errors

Error messages appear when an error is detected by the machines operating system. When the error is active and is cancelled by the user, the machine goes out of safe mode and tries to recover. If the error is not cleared by retrying, the error reappears.

► *If the error message returned after the appropriate action, please contact your dealer.*

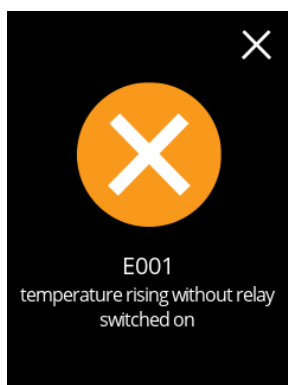

6.2a

Example display for errors.

These errors are stored in a log file (§5.4.2 on p.89).

code	description	action
E001	temperature rise while relay disengaged	<ul style="list-style-type: none"> <li>• reset the message on the screen</li> <li>» if the error persists, contact your dealer</li> </ul>
E002	temperature sensor out of range	<ul style="list-style-type: none"> <li>• reset the message on the screen</li> <li>» if the error persists, contact your dealer</li> </ul>
E003	magnetic valve unexpectedly opened	<ul style="list-style-type: none"> <li>• reset the message on the screen</li> <li>» if the error persists, contact your dealer</li> </ul>
E004	temperature not rising while relay engaged	<ul style="list-style-type: none"> <li>• reset the message on the screen</li> <li>» if the error persists, contact your dealer</li> </ul>
E005	<i>not available</i>	
E006	water supply failure	<ul style="list-style-type: none"> <li>• reset the message on the screen, if the error repeats verify the following:</li> <li>» check that the water tap is open</li> <li>» check that the water supply hose is not kinked</li> <li>» check whether water comes out of the water tap</li> <li>» if the error persists, contact your dealer</li> </ul>

code	description	action
E007	<i>not used</i>	
E008	bus system communication error	• reset the message on the screen
		» if the error persists, contact your dealer
E009	pump motor malfunction	• reset the message on the screen
		» if the error persists, contact your dealer
E010	mixer motor not detected	• reset the message on the screen, if the error repeats verify the following:
		» check that the mixing bowl is clean and not blocked
		» if the error persists, contact your dealer
E011	canister motor malfunction	• reset the message on the screen, if the error repeats verify the following:
		» remove the canister and try again
		» remove the ingredient powder from the canister and try again
		» if the error persists, contact your dealer
E012	coin mechanism missing	• reset the message on the screen, if the error repeats verify the following:
		» check whether the payment device is correctly connected
		» if the error persists, contact your dealer
E013	coin mechanism defective	• reset the message on the screen, if the error repeats verify the following:
		» check whether the payment device is correctly connected
		» if the error persists, contact your dealer
E014	coin mechanism blocked	• reset the message on the screen, if the error repeats verify the following:
		» check the payment device for any blockages
		» if the error persists, contact your dealer
E015	coin mechanism sabotaged	• reset the message on the screen, if the error repeats verify the following:
		» check the payment device for any damages
E016	coin mechanism communication error	• reset the message on the screen, if the error repeats verify the following:
		» check whether the payment device is correctly connected

<b>code</b>	<b>description</b>	<b>action</b>
E017	coin mechanism general error	<ul style="list-style-type: none"><li>• reset the message on the screen, if the error repeats verify the following:<ul style="list-style-type: none"><li>» check whether the payment device is correctly connected</li></ul></li></ul>
E018	cashless device general error	<ul style="list-style-type: none"><li>• reset the message on the screen, if the error repeats verify the following:<ul style="list-style-type: none"><li>» check whether the payment device is correctly connected</li></ul></li></ul>
E019 - E025	<i>not used</i>	
E026	contact your dealer for necessary maintenance	<ul style="list-style-type: none"><li>• reset the message on the screen, contact your dealer for required maintenance (the error message will occur more frequently than the warning message W020)</li></ul>

## 7. Appendix

### 7.1 Filter information and water hardness

	very soft	soft	average	moderate	hard
°dH	0 - 4	4 - 8	8 - 12	12 - 18	18 - 30
°fH/°TH	0 - 7	7 - 15	15 - 22	22 - 32	32 - 54
°e / Clark	0 - 5	5 - 10	10 - 15	15 - 23	23 - 38
mmol/l	0 - 0.72	0,72 - 1.43	1.43 - 2.15	2.15 - 3.22	3.22 - 5.37
descale	2000 l.	1500 l.	1000 l.	500 l.	250 l.

- ▶ The capacity of a water filter depends on the type and local hardness of the water.
- ▶ See §5.1.6 on p.30 to set the water hardness.

### 7.2 Door switch functionality



When the door opens the safety switch is activated and a message is shown.

The following hardware will become inactive:

- all mixers
- all canisters
- boiler
- appliances that are connected to the 24 V safety of the bus system

- ▶ When the door switch is activated during dosing of a beverage, the dosing is cancelled and the mixer cup is cleaned by a post flush.

### 7.3 Basic machine configurations

**Bolero 11**

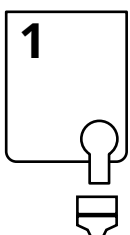

**Bolero 21**

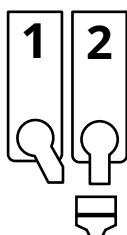

## 7.4 PIN code security settings

The table below lists the available menu options associated with the PIN codes.

access to	PIN1	PIN 2
machine information	yes	yes
counters	yes	yes
water filter management	yes	yes
cleaning instructions	yes	yes
descale	yes	yes
rinse the mixing system	yes	yes
update software	yes	no
import machine settings	yes	no
export machine settings	yes	no
update history	yes	no
export machine log	yes	no
reset to factory settings	yes	no
pump calibration	yes	no
canister calibration	yes	no
I/O tests	yes	no

► *Menu items secured by PIN codes will be greyed out, see §5.3.11 on p.78 to set the PIN codes.*

## 7.6 Special functions

By using a “secret key combination” special features can be activated.

### 7.6.1 Cancel beverage on/off

See §5.3.13 Connected devices on p.84

- Reason of this feature is that the customer can choose if the beverage can be cancelled or not when a payment system is connected.

### 7.6.2 Quick rinse



By pressing the S M L on the beverage selection screen for 5 seconds the quick rinse is immediately activated with 90 ml (hot water).

- To set this function, see §5.1.4 Hot-key rinsing function on p.27



### 7.6.3 Demo mode on/off

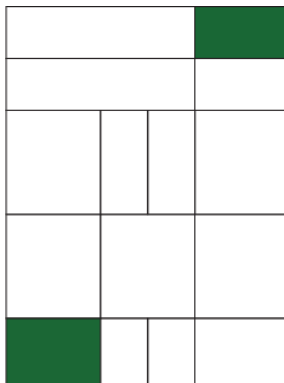

By pressing on the green parts simultaneously for 10 seconds the demo mode is activated.

- The demo mode is a function which can be enabled for marketing purposes.





